

FURUNO®

New Autopilot
with Unique
Features!

Self-learning, Adaptive Autopilot

NAVpilot™ 500

- Revolutionary "Adaptive" technology continuously improves performance for exact and safe navigation
- Hi-Resolution 4.6" silver bright LCD display
- Multiple steering modes - AUTO (Heading Control System), NAV (Track Control System), Advanced AUTO, AUTO Work, etc.
- Simple operation - One touch Stand-by, Auto, Dodge and Nav controls
- Heavy Duty Solenoid output for a variety of vessels and hydraulic pump combos
- Precision XTE control (.001 nm)
- Networkable displays provide Multi-station capability (max 6)
- Multi language capability
- Customizable display modes; Auto, XTE track, rudder angle, L/L, highway, compass rose, wind, and depth
- Unique FishHunter™ modes - orbit and clover leaf navigation
- Compass options include; fluxgate compass PG-500, GPS Satellite compass SC-60
- Simple installation and auto set-up

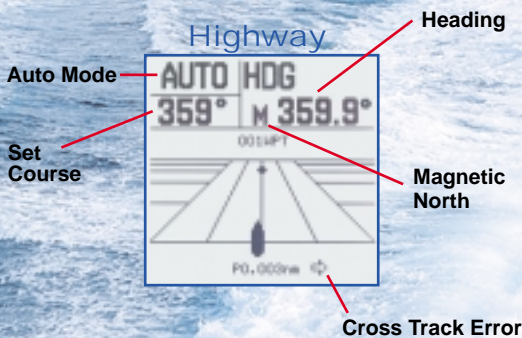

The NavPilot™ 500 is a revolutionary autopilot designed for a variety of vessels. The operation modes include Auto (Heading control), Advanced Auto utilizing automatic ground tracking control, Auto Work for net towing and NAV mode (Track control system referenced on precision cross track error) when integrated with navigation sensors.

The NavPilot™ 500 features a self-learning and adaptive software algorithm, providing the ultimate in course keeping capability. Essential parameters dynamically adjust for vessel speed, trim, draught, tide and wind effects, dead band, weather, etc. These parameters are stored in system memory and continuously optimized.

Simple one-touch mode selection provides reliable steering and course control. Multiple customizable display modes include Rudder angle, Heading, Highway, Compass rose, Wind, Nav Info, etc.

FishHunter™ is a unique feature that helps perform Orbit or Clover Leaf maneuvers around fish targets when a target is detected by a Furuno sounder, sonar, or radar outputting the NMEA TLL sentence. The orbit mode is activated when the MOB is received from Furuno GPS navigator.

Multi-station capability, maximum of six stations, is available on the high speed bus line.



The future today with FURUNO's electronics technology.

FURUNO ELECTRIC CO., LTD.

9-52 Ashihara-cho, Nishinomiya City, Japan Phone: +81 (0)798 65-2111
Fax: +81 (0)798 65-4200, 66-4622 URL: www.furuno.co.jp

Catalogue No. M-1526

TRADE MARK REGISTERED
MARCA REGISTRADA

SPECIFICATIONS OF NavPilot 500

Operational Mode

- Auto:** Auto steering with a fixed heading
- Advanced Auto:** Auto steering counteracting the effects of wind, tide, swell, or fishing operations)
- NAV:** Track Control System monitoring external XTE or Course-To-Steer info
- Auto Work:** Parameter optimization to adopt to slow trolling or trawling vessel

Drive System

Reversible Hydraulic (Up to 25 Amp Continuous) or Solenoid Drive Output

Display Type

Graphic Mono LCD (160 x 160 pixels)

Display Modes

Customizable Heading, Course, Rudder Angle, Highway, Compass, Wind and Navigation Information

Languages

English, French, German, Italian, Portuguese, Spanish

Heading Sensors

PG-500 Fluxgate or Satellite Compass SC-60/120 by Furuno AD10, NMEA0183 HDG or HDM (5 Hz or higher) or Furuno AD-100 Converter

Nav Sensors via NMEA0183 Interface

Furuno GP30 Series, GP1650W/1850W series, NavNet series, other non-Furuno GPS (correct NMEA0183 data required)

Parameters Settings

Auto Setup, Adaptive (Self-Learning) with manual setting override:
Weather, Rudder ratio, Counter rudder, course changing rate, Rudder angle limits

Alarms

Power failure, XTE, nav signal error, Speed, Arrival, Watch, Temp and Depth

ENVIRONMENTAL CONDITIONS

EMC, Vibration, Climatic: Complies with IEC 60945 (Display - USCG CFR46 Waterproof Display Rating)

EQUIPMENT LIST

Standard

- | | |
|---|--------|
| 1. Control Unit | 1 unit |
| 2. Processor Unit | 1 unit |
| 3. Rudder Feedback Unit | 1 unit |
| 4. Installation Materials and Spare Parts | 1 set |

Option

1. Remote Controller (Lever type) FAP-6221/6222
2. Dodge Type Remote Controller FAP-6231/6232
3. Hanger
4. Cable for Remote Controller MJ-A10SPF0001-60/120
5. Cable for Control Unit MJ-A7SPF00012-100
6. Junction Box FAP-6800

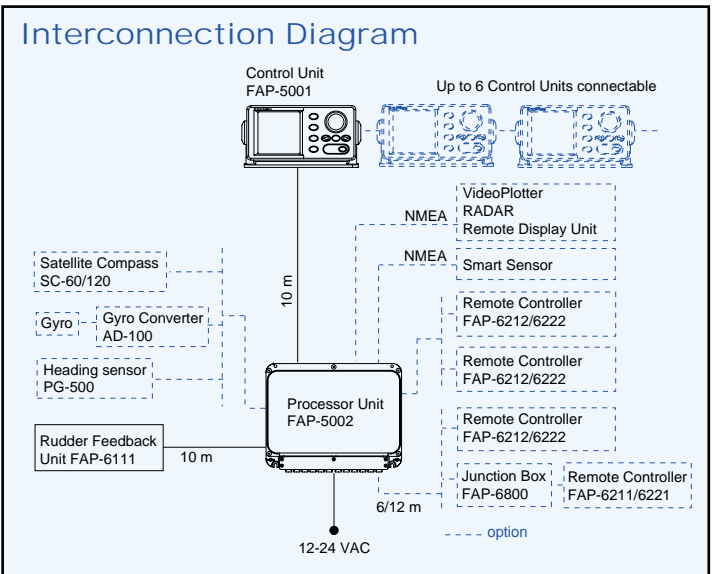

Control Unit FAP-5001

0.7 kg 1.5 lb

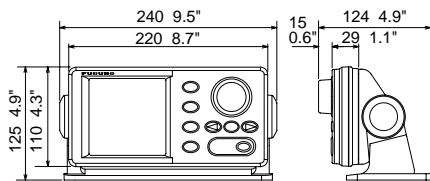

Cutout for Panel Mount

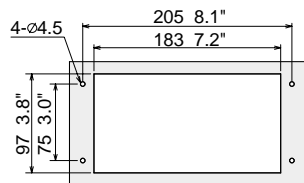

Processor Unit FAP-5002

1.9 kg 4.2 lb

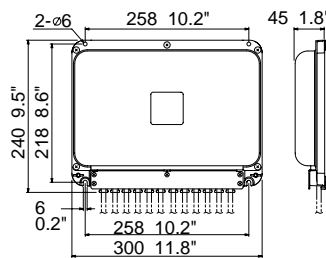

Remote Controller FAP-6221/6222

1.8 kg 4.0 lb

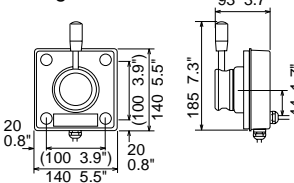

Rudder Feedback Unit FAP-6111

0.5 kg 1.1 lb

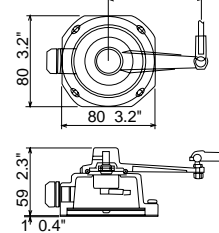

Dodge Type Remote Controller FAP-6211/6212

0.5 kg 1.1 lb

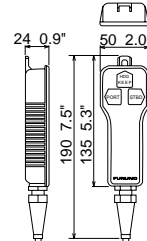

SPECIFICATIONS SUBJECT TO CHANGE WITHOUT NOTICE

FURUNO U.S.A., INC.

Camas, Washington, U.S.A.
Phone: +1 360-834-9300 Telefax: +1 360-834-9400

FURUNO (UK) LIMITED

Denmead, Hampshire, U.K.
Phone: +44 2392-230303 Telefax: +44 2392-230101

FURUNO FRANCE S.A.

Bordeaux-Mérignac, France
Phone: +33 5 56 13 48 00 Telefax: +33 5 56 13 48 01

FURUNO ESPANA S.A.

Madrid, Spain
Phone: +34 91-725-90-88 Telefax: +34 91-725-98-97

FURUNO DANMARK AS

Hvidovre, Denmark
Phone: +45 36 77 45 00 Telefax: +45 36 77 45 01

FURUNO NORGE A/S

Ålesund, Norway
Phone: +47 70 102950 Telefax: +47 70 127021

FURUNO SVERIGE AB

Västra Frölunda, Sweden
Phone: +46 31-7098940 Telefax: +46 31-497093

FURUNO SUOMI OY

Helsinki, Finland
Phone: +358 9 341 7570 Telefax: +358 9 341 5716

0303XY Printed in Japan