

User Manual

Ultrasonic Anemometer

Doc No: 1405-PS-0019

Issue 30



APPLIES TO WINDSONIC OPTION 1-3 UNITS SUPPLIED FROM MARCH 2016

WITH SERIAL NUMBERS 16110001 ONWARDS AND
WITH FIRMWARE 2368-110-01 ONWARDS.

APPLIES TO WINDSONIC 75 OPTION 1 AND 2 UNITS

SUPPLIED WITH FIRMWARE 2368-107-01

APPLIES TO WINDSONIC 75 OPTION 3 UNITS

SUPPLIED WITH FIRMWARE 2816-100

APPLIES TO OPTION 4 SDI-12 UNITS FROM JUNE 2011

WITH SERIAL NUMBERS 11220007 ONWARDS.

Gill Instruments Limited
Saltmarsh Park, 67 Gosport Street, Lymington,
Hampshire, SO41 9EG, UK
Tel: +44 1590 613500, Fax: +44 1590 613555
Email: anem@gillinstruments.com Website: www.gillinstruments.com

Table of Contents

1. Welcome to the Windsonic user manual	4
1.1. Overview of Content	4
1.2. Description of Icons	4
1.3. General Notes	5
1.4. User Manual Revision History	5
2. Product Overview	6
2.1. Windsonic Specification	6
3. Pre-Installation	7
3.1. Equipment supplied	7
3.2. Windsonic Accessories	7
3.3. Windsonic CE, UKCA, FCC conformity	8
3.4. Right to change and revise	8
3.5. Packaging	8
3.6. WindSonic Specification	8
3.7. Downloadable Software	8
3.8. WindSonic Part Numbers	9
4. Requirements & Installation	10
4.1. Installation requirements	10
4.2. Installation Guidelines	11
4.3. Bench system test	12
4.4. Electrical	12
4.4.1. Cable	12
Cable Length	12
4.4.2. Power Supply	13
4.5. Connecting to a PC using RS232 (Option 1 Sensor) Power and Communications Cable	14
4.6. Connecting WindSonic Option 2 or 3 set for default RS422 to a PC using an RS232 Safe Mode Connection	15
4.7. Changing an Option 2 or 3 Sensor set for RS232 back to RS422	16
4.8. Connecting to a PC using RS422 (Option 2 or 3)	16
4.9. Using RS485 (2 wire point to point) with Option 2 or 3 units	17
4.10. Using the Analogue Output (Option 3)	18
5 Mechanical	19
5.1 Orientation	19
5.2 Alignment	19
5.3 Mounting	19
6 MESSAGE FORMATS	22
6.1 Gill format– Polar, Continuous (Default format)	22
6.2 Gill format – UV, Continuous	24
6.3 NMEA Format (NMEA status codes)	26
6.4 NMEA Format (Gill status codes)	27

6.5	Gill format – Tunnel Mode (UU, Continuous).....	28
6.6	Analogue Outputs and Options	29
6.6.1	Voltage or Current output	29
6.6.2	Analogue Output Modes	29
6.6.3	Polar mode direction wraparound	29
6.7	Wind Speed scaling.....	30
6.8	Tunnel mode.....	30
6.9	Analogue Output rate.....	30
6.10	Disabled outputs.....	30
6.11	Analogue Output Conditions	30
6.12	Analogue Output Conditions	31
6.13	Error condition reporting.....	31
7.	SDI-12 WindSonic	34
7.1.	Cable Type	34
7.2.	Cable Length	34
7.3.	Connecting to an SDI-12 Interface (Option 4)	34
Appendix A - Technical Specification (Options 1, 2 & 3).....		35
Appendix B - Cable Assembly		38
Appendix C - WindSonic Default Setup.....		42
Appendix D - Windsonic Safe mode.....		43
Appendix E - Configuring.....		47
Appendix F – SDI-12 Commands.....		53
Appendix G – Configuration Commands		57
Appendix H - Polled Mode Commands		64
Appendix I - Wind View Software.....		65
Appendix J - Status Codes.....		71
Appendix K - Maintenance & Fault-Finding		72
Appendix L - Glossary & Abbreviations.....		75
Appendix M - Guarantee & FCC.....		76

1. Welcome to the Windsonic user manual

About this manual

This manual provides the information needed to get the best results from Windsonic. The most recent version of this manual is available at gillinstruments.com.

Please read this manual before setting up and installing Windsonic.



1.1. Overview of Content

The manual is split into 8 chapters. Each chapter represents an activity in the use of the product. Additional detailed information is contained in the Appendices at the end of the manual.

- Chapter 1 explains how the manual is set out
- Chapter 2 provides a brief overview of the product
- Chapter 3 provides the information needed to fast set-up the product
- Chapter 4 provides the information needed to pre-install the product
- Chapter 5 provides the information needed to install the product
- Chapter 6 provides mechanical guidance for product and mounting bracket
- Chapter 7 explains message formats
- Chapter 8 explains SDI-12

1.2. Description of Icons

The following icons are used in this manual.

Icon	Description
	A note that is important and that should be observed
	Information or a recommendation to ensure best results
	The start of a set of instructions

1.3. General Notes



Before Windsonic is used for the first time it is essential to read and understand this manual. Please keep the manual safe for future reference.



Care should be taken with Windsonic at all times. The product should be transported to site in the box, and only removed when ready to install.



During installation Windsonic should be supported and care should be taken not to drop the product



Care should be taken when wiring the Windsonic to power and communications.



Maintenance should be limited to the procedures described in this manual. Additional maintenance or cleaning may damage the sensors.



No attempt should be made to open or repair any of the parts of the product. Any attempt to dismantle any part of the product will invalidate the warranty provided by Gill Instruments.

1.4. User Manual Revision History

Document Version	Release Date	Key Changes
Iss 30	Nov 22	New Manual Template

2. Product Overview

The Gill WindSonic wind sensor is a very robust, lightweight unit with no moving parts, outputting wind speed and direction. The units of wind speed, output rate and formats are all user selectable.

The WindSonic can be used in conjunction with a PC, data logger or other device, provided it is compatible with one of the standard communication formats provided by the WindSonic.

WindSonic (options 1, 2 and 3) may be configured using Wind software which is available, free of charge, from the Gill website www.gillinstruments.com. The output message format can be configured in Gill format, in Polar or UV (2-axis) format, and to either Polled (requested by host system) or Continuous output. Alternatively, it can be configured in NMEA (0183 Version 3). These are described in Section 9 MESSAGE FORMATS.

WindSonic (option 4) SDI-12 may not be re-configured in any Gill output format and format is SDI-12 (V1.3) and described in Section 14 SDI-12 COMMANDS.

2.1. Windsonic Specification

The Windsonic specification can be found in Appendix A (page 35) of this manual.

3. Pre-Installation

3.1. Equipment supplied

Item	Quantity
WindSonic	1
Connector and Mounting Screws comprising: -	
9 Way connector	1
Connector Contacts	9
Sealing Gland	1
Sealing Washer	1
Washer shake proof	3
Screws – M5 stainless steel	3

After you have successfully set up the WindSonic, we strongly advise that you then go back and read the rest of the manual to ensure that you get the best results from the WindSonic.

3.2. Windsonic Accessories

A range of accessories is available to support Windsonic. A list of accessories is shown below.

More information, and the most up to date list of accessories can be found at gillinstruments.com.

Accessory	Gill Instruments Part Number
Cable 4 Pair, twisted and shielded 24 AWG	026-03156
Cable 3 Pair, twisted and shielded 24AWG	026-02660
Cable 15 metres (4 twisted pairs (seven contact wires), shielded 24AWG – Seven Connector pins attached to one end and eight stripped wires the other).	1405-10-080
WindSonic connector (1 supplied as standard see above)	1405-PK-069
WindSonic Support Tube 0.5 metre (Aluminium)	1405-30-056
Bracket for mounting to a Pole, includes a WindSonic Adaptor	1771-PK-115

3.3. Windsonic CE, UKCA, FCC conformity

This product carries the CE and UKCA marks. A copy of the Declaration of Conformity can be downloaded from gillinstruments.com.

Note: This equipment has been tested and found to comply with the limits for a Class A digital device, pursuant to part 15 of the FCC Rules. These limits are designed to provide reasonable protection against harmful interference when the equipment is operated in a commercial environment. This equipment generates, uses, and can radiate radio frequency energy and, if not installed and used in accordance with the instruction manual, may cause harmful interference to radio communications. Operation of this equipment in a residential area is likely to cause harmful interference in which case the user will be required to correct the interference at his own expense.

EMC

Immunity test requirements for equipment intended to be used in an industrial electromagnetic environment have been applied. These test levels are above the levels expected to be experienced in normal use due to the above recommended siting conditions, but disturbances may be expected. If any interruption to performance is experienced due to external electromagnetic signals the product will automatically and autonomously return to specification once the signals levels have diminished.

3.4. Right to change and revise

Gill Instruments reserve the right to change or revise the product without notice or the obligation to notify any person or organisation of such change or revision.

Gill Instruments reserve the right to change or revise the information supplied in this manual without notice or the obligation to notify any person or organisation of such change or revision.

The reproduction and distribution of the documentation and software supplied with this product and the use of its contents is subject to written authorization from Gill Instruments.

3.5. Packaging

Whilst the WindSonic is being moved to its installation site, the unit should be kept in its inner packaging. All the packaging should be retained for use if the unit has to be returned at any time, or if a self-test is performed.

3.6. WindSonic Specification

The WindSonic Specification can be found in Appendix A

3.7. Downloadable Software

Two software packages are available to help customers use Windsonic.

- Wind - this software can be used to set-up the product
- WindView - this software can be used to view the data provided by the product

Both software packages can be downloaded from gillinstruments.com.

3.8. WindSonic Part Numbers

1405-PK-021	Black WindSonic Option 1 – RS 232 output only
1405-PK-068	White WindSonic Option 1 – RS 232 output only
1405-PK-038	Black WindSonic Option 2 – RS 232, 422 & 485 (point to point) output
1405-PK-072	White WindSonic Option 2 – RS 232, 422 & 485 (point to point) output
1405-PK-040	Black WindSonic Option 3 – RS 232, 422, 485 p to p & analogue output
1405-PK-073	White WindSonic Option 3 – RS 232, 422, 485 p to p & analogue output
1405-PK-100	Black WindSonic Option 4 – SDI-12 output only
1405-PK-110	White WindSonic Option 4 – SDI-12 output only
1405-PK-400	Black WindSonic 75 Option 1- RS232 output only
1405-PK-420	Black WindSonic 75 Option 2 RS 232, 422 & 485 (point to point) output
1405-PK-430	Black WindSonic 75 Option 3 RS 232, 422 & 485 p to p & analogue op.

4. Requirements & Installation



4.1. Installation requirements

Host system - One of the following:

- PC fitted with a suitable interface to match the chosen communication format (RS232, RS422, or RS485 (point to point), compatible with the WindSonic option selected, and a suitable Terminal Emulation software package. For example, TeraTerm, puTTY or Wind Software that is available from the Gill website at <https://gillinstruments.com/downloads/>
 - Gill WindDisplay (WindSonic option 2 or 3 only).
 - Other equipment with input/output compatibility to the WindSonic Option selected. For example, Data loggers.

Cable - To connect between the WindSonic and the host system

See Section 4.4.1 Cable type for cable specification.

- There are restrictions on the maximum cable lengths for correct operation.
- The cable should be routed up the inside of the mounting tube.

Mounting tube (e.g., 0.5-metre-long Gill part 1405-30-056)

- Standard tube 1.75 inches (44.45mm) Outside Diameter x 3mm wall thickness.
- **Note it is important that the correct diameter tube is used to prevent damage to the WindSonic lower moulding when tightening the screws.**

See Figure 3, Alignment & Mounting Details on page 21.

- For non-hostile environments, Aluminium tube can be used.
- For hostile environments, you should select a material suitable for the intended environment. For example, stainless steel 316 for marine use.

Mounting Bracket (Gill Part 1771-PK-115)

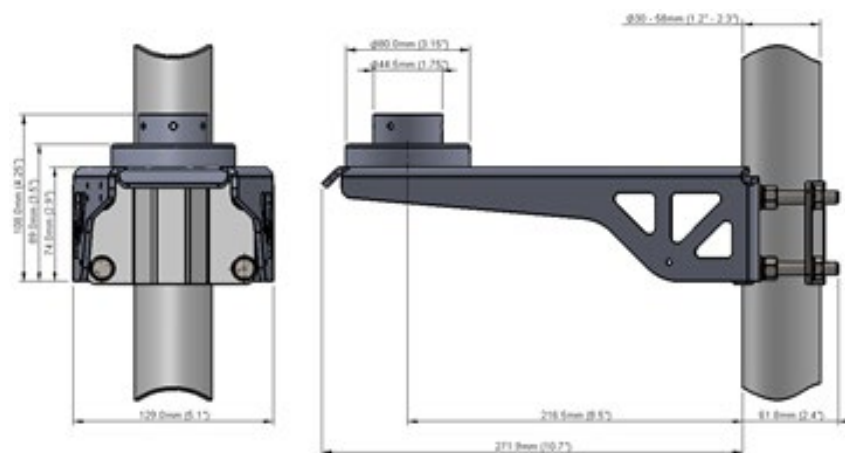



Do NOT remove the black “rubber” transducer caps. Warranty is void if the coloured security seal is damaged or removed.

4.2. Installation Guidelines

The WindSonic has been designed to meet and exceed the stringent standards listed in its specification. Operating in diverse environments all over the world, WindSonic requires no calibration and adjustment whatsoever.

As with any sophisticated electronics, good engineering practice should be followed to ensure correct operation.

- Always check the installation to ensure the WindSonic is not affected by other equipment operating locally, which may not conform to current standards, e.g., radio/radar transmitters, boat engines, generators etc.
Guidelines –
- Avoid mounting in the plane of any radar scanner – a vertical separation of at least 2m should be achieved.
- Radio transmitting antennas, the following minimum separations (all round) are suggested.
 - ❖ VHF IMM – 1m
 - ❖ MF/HF – 5m
 - ❖ Satcom – 5m (avoid likely lines of sight)
- Use cables recommended by Gill. If cables are cut and re-connected incorrectly (perhaps in a junction box) then EMC performance may be compromised if cable screen integrity is not maintained.
- Earth loops should not be created – wire the system in accordance with the installation guidelines.
- Ensure the power supply operates to the WindSonic specification at all times.

Avoid turbulence caused by surrounding structures that will affect the accuracy of the WindSonic such as trees, masts and buildings. Ideally sensors should be mounted on the prevailing wind side of the site.

The WMO make the following recommendations:

The standard exposure of wind instruments over level open terrain is 10m above the ground. Open terrain is defined as an area where the distance between the sensor and any obstruction is at least 10 times the height of the obstruction.

If mounting on a building, then theoretically the sensor should be mounted at a height of 1.5 times the height of the building.

If the sensor is to be mounted on a mast boom, part way up a tower or mast, then the boom should be at least twice as long as the minimum diameter or diagonal of the tower. The boom should be positioned on the prevailing wind side of the tower.

4.3. Bench system test



Prior to physically mounting the WindSonic in its final location, we strongly recommend that a bench system test is carried out to confirm the system is configured correctly, is fully functional and electrically compatible with the selected host system and cabling (preferably utilising the final cable length). The required data format, units, output rate, and other options should also all be set up at this stage.

4.4. Electrical

4.4.1. Cable Type

A RS422 compatible cable should be used, with the number of twisted pairs matching the application.

Generic description – Twisted pairs with drain wire, screened with aluminised tape, with an overall PVC sheath of 6mm-12mm outer diameter. Wire size 7/0.2mm (24 AWG).

The table shows some suitable manufacturers' references; other manufacturers' equivalents can be used.

Application	No. of pairs	Gill ref. 24 AWG	Belden ref. 24 AWG	Batt electronics ref. 24 AWG
RS 232	3	026-02660	9730	91030
RS 422	4	026-03156	9728	91199

Cable Length

The maximum cable length is dependent on the chosen communication format (RS232, RS422 or RS485 (point to point), the baud rate, and, to a lesser extent, on the cable type and the local electrical 'noise' level.

The table shows the typical maximum lengths at the given baud rates, using the recommended cable. If any problems of data corruption etc. are experienced, then a slower baud rate should be used. Alternatively, a thicker or higher specification cable can be tried

WindSonic Option	Communication format	Baud rate	Max. cable length
Option 1, 2 and 3	RS232	9600	6.5 m (20 ft)
Option 2 and 3	RS422 or RS485 point to point	9600	1 km (3200 ft)
	Analogue – Voltage o/p	N/A	6.5m (20 ft)
Option 3	Analogue – Current o/p	N/A	Resistance dependent (Max 300 Ω)

4.4.2. Power Supply

WindSonic Option 1 and 2 Units; Require a DC supply of between 5V – 30 V DC (30V DC max).

WindSonic Option 3 Units; Require a DC supply of between 7V– 30 V DC (30V DC max).

WindSonic current drain depends on variant i.e. Option 1, RS232 approximately 9mA at 12v dc rising to 44mA for Analogue variant.

Lowest power consumption is obtained with the following configuration: -

M2, P20, B3, S9 (approximately 5.5mA at 12v).

WindSonic 75 Option 1, 2 and 3 Units; Require a DC supply of between 12V – 30 V DC (30V DC max).

WindSonic 75 Option 1 and 2 current drain is typically approximately 13mA at 12v dc.

4.5. Connecting to a PC using RS232 (Option 1 Sensor) Power and Communications Cable

1. The cable length for reliable operation is limited to 6.5m (20ft).
(See Section 4.4.1 Cable length.)
2. For longer cable runs, we recommend using the WindSonic configured with RS422 output, and a RS422/232 converter at the PC.
3. Wiring connections below are not applicable to WindSonic Options 2 and 3 set for RS232 operation.

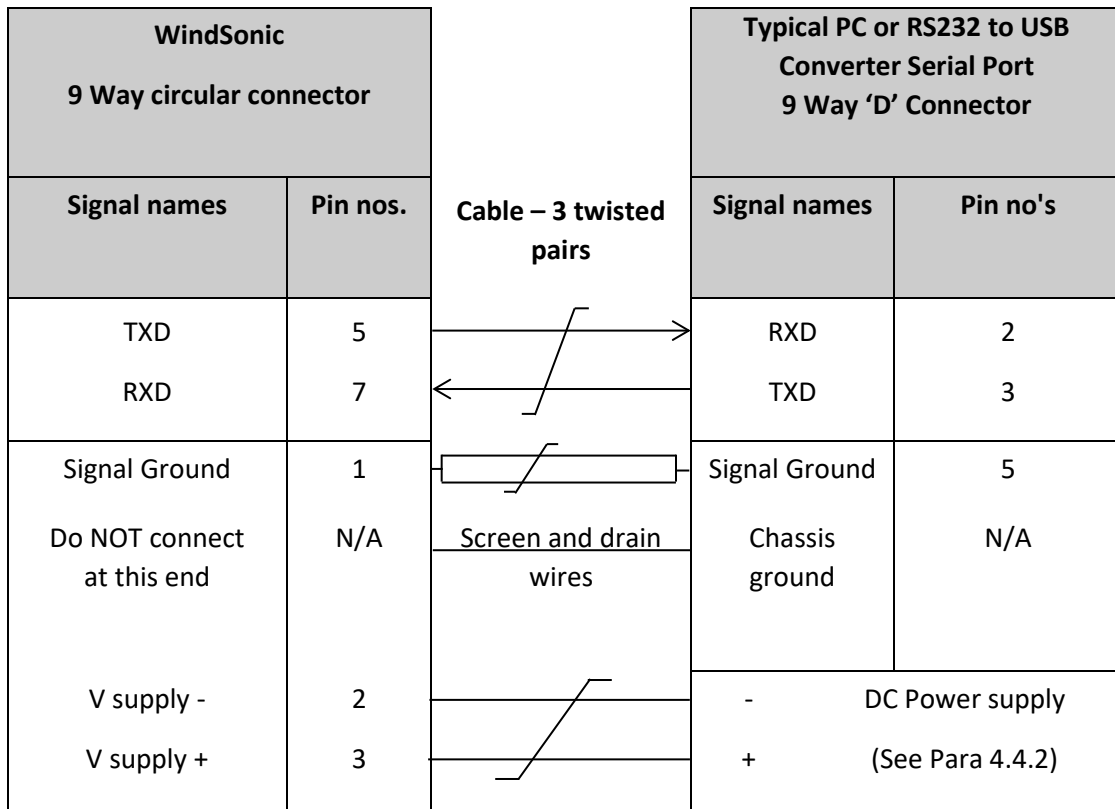

Default Settings

The WindSonic Option 1 unit is factory configured with the following default settings:

M2, U1, O1, L1, P1, B3, H1, NQ, F1, E3, T1, S4, C2, G0, K50,

4.6. Connecting WindSonic Option 2 or 3 set for default RS422 to a PC using an RS232 Safe Mode Connection.

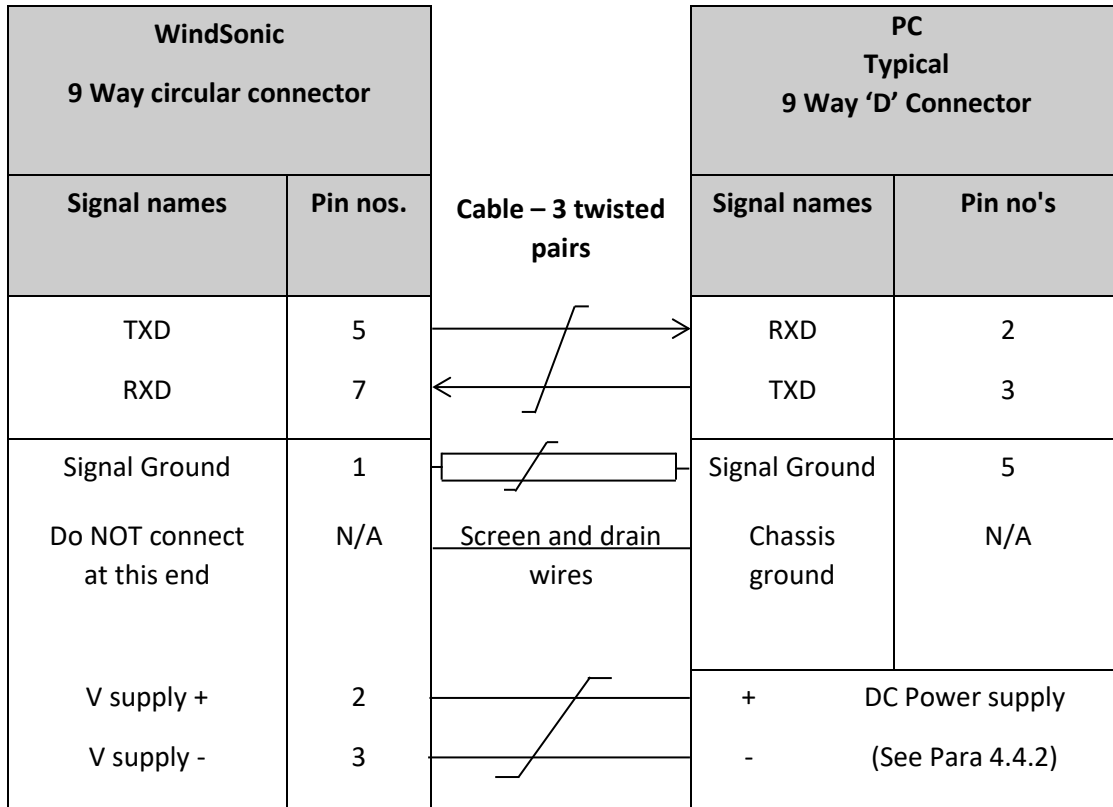

1. Connect the Option 2 or 3 WindSonic as per the above connection diagram.
2. With WindSonic power off, set up a Terminal connection as per Page 48 **but with the Baud rate set to 19200 (this can be at variance with the original WindSonic Baud rate setting).**
3. **Hold down** the * character (shift 8) and then apply power to the WindSonic. After approximately 3 seconds the unit will respond with **Safe Mode**.
4. To change output communication from RS422 to RS232 then remove any * characters on screen.
5. Type E3 and press Enter (changes E2 setting to E3).
6. E3 will be seen twice on screen to confirm the setting change to RS232 has occurred.
7. Change any other configuration settings as required.
8. Type Q and press Enter to go back into measurement mode (garbled data may appear on screen if the original WindSonic Baud rate setting is not 19200bauds).
9. If required close the 19200-baud HyperTerminal connection and re-open at the WindSonic Baud rate. If a continuous data mode has been previously chosen, then data will scroll on screen.
See Appendix D

(Note that supply voltage connections are reversed compared to the Option 1 RS232 unit. Damage will not occur from a reverse voltage connection).

4.7 Changing an Option 2 or 3 Sensor set for RS232 back to RS422.

Connect the Option 2 or 3 WindSonic as per Para 4.6.

Repeat instructions shown in Para 4.6 except that in Safe Mode set the E Command to E2 etc.

4.8 Connecting to a PC using RS422 (Option 2 or 3)

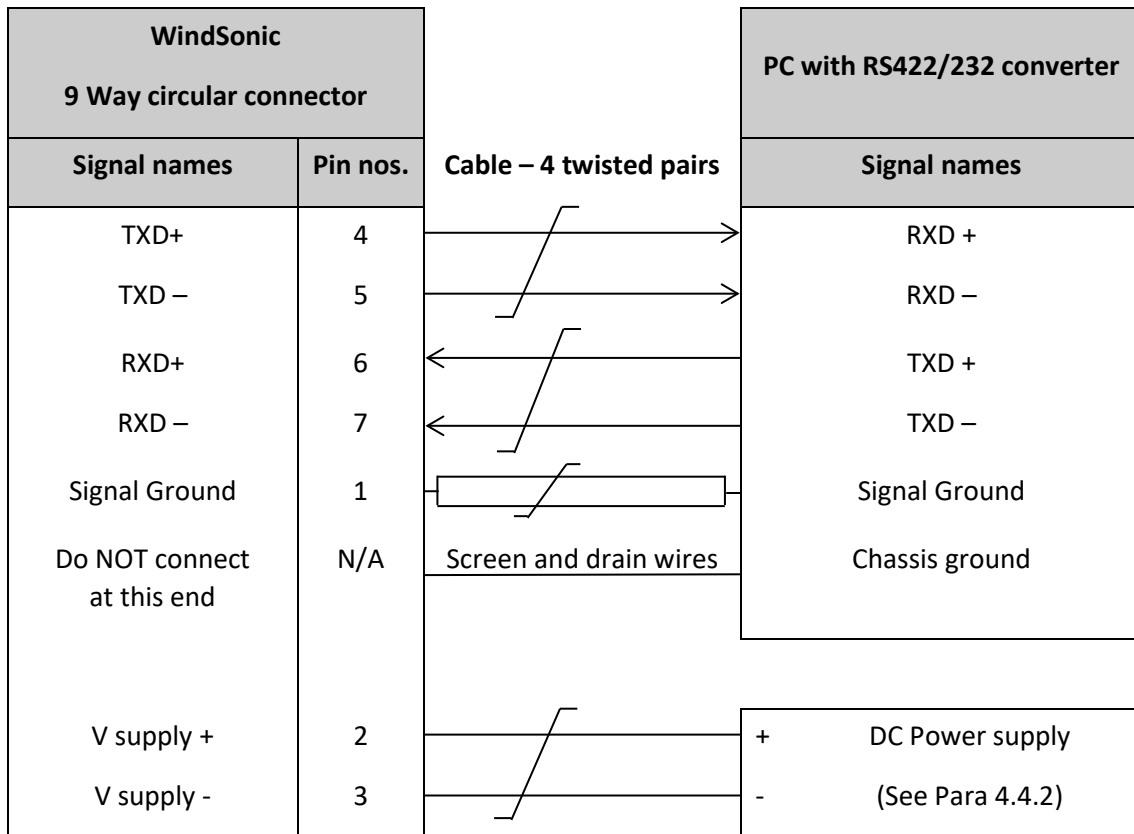

Notes

WindSonic to be set for RS422/RS485 mode (E2, default).

Analogue Outputs are also simultaneously available from the **Option 3** unit.

Default Settings

The **WindSonic Option 2 and 3** unit is factory configured with the following default settings:

M2, U1, O1, L1, P1, B3, H1, NQ, F1, E2, T1, S4, C2, G0, K50

See Appendix E - Configuring for further detail

4.9 Using RS485 (2 wire point to point) with Option 2 or 3 units

1. The unit must be set for RS422/485 mode (E2 setting).
2. WindSonic must be set in Polled mode, a node address letter may be given if required.
See Section 6.1 WindSonic node address.
3. Customers may poll using terminal software (NOT supplied).
4. As unit is point to point only it cannot be networked with other RS485 2 wire devices.

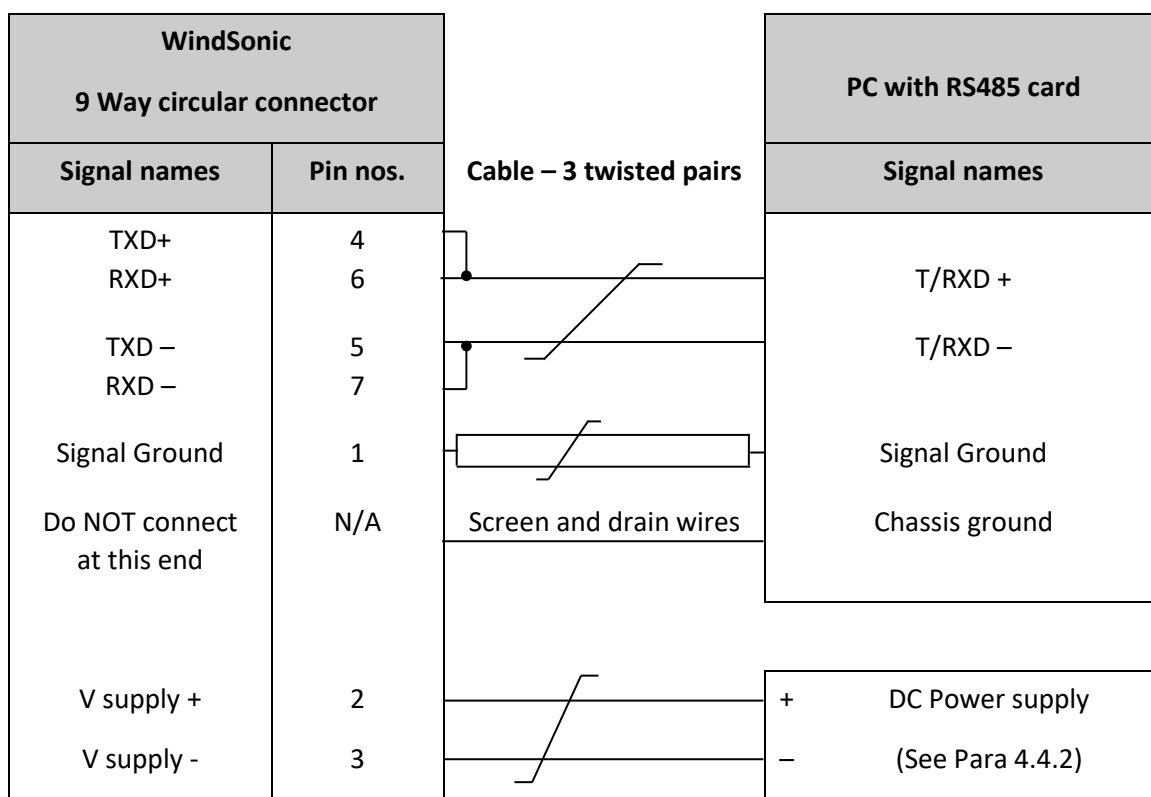

Analogue Outputs are also simultaneously available from the Option 3 unit.

4.10 Using the Analogue Output (Option 3)



1. If the Current output is used, the total output load **MUST** be below 300 ohms, including the cable resistance.
2. The current output loads must be returned to Signal Ground.
3. Reconfiguration of the analogue output requires a digital connection (See section 6 & Appendix E).
4. In addition, the digital output can be connected if required using RS232, 422 or 485 point to point, as shown in the previous sections.

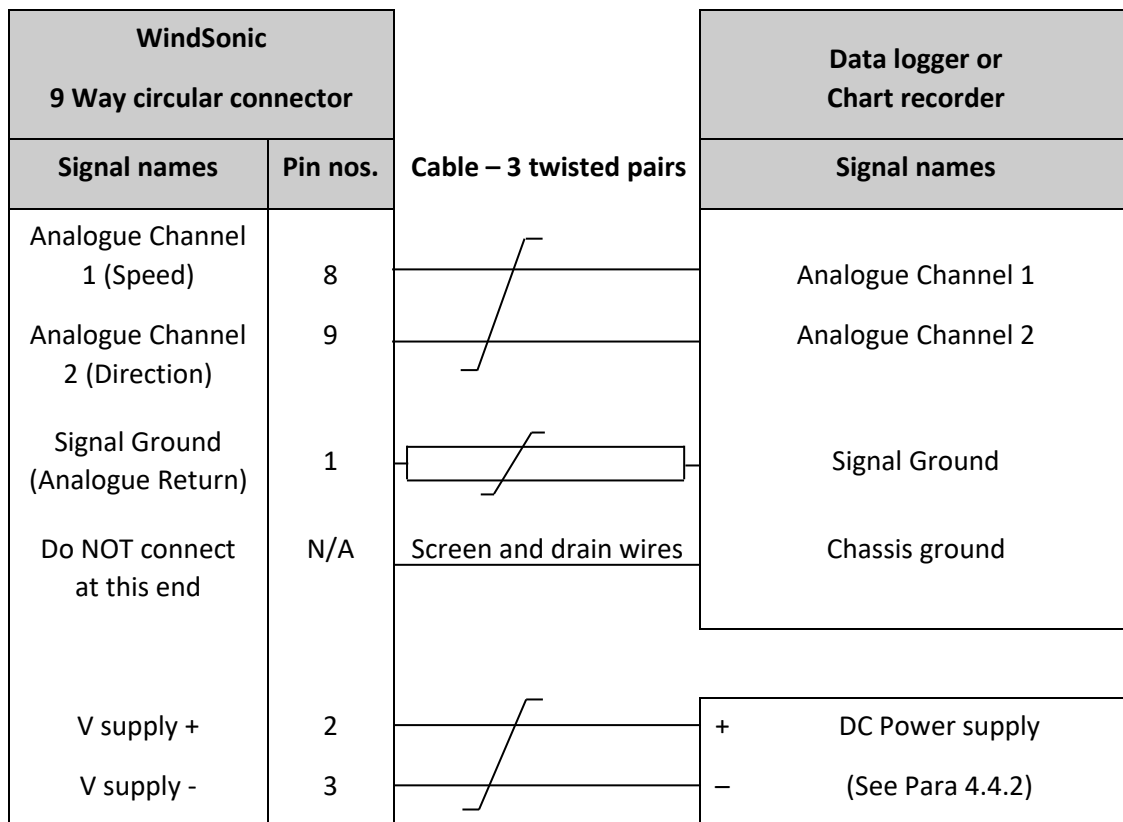

5 Mechanical



Before installing, see note at Section 5.3 Bench system test.

5.1 Orientation

Normally the WindSonic is mounted on a vertical tube, ensuring a horizontal Measuring Plane. *See Figure 3 Alignment & Mounting details*

For indoor use the unit may be mounted with the Measurement Plane set to any required orientation.

5.2 Alignment

The WindSonic should be aligned to point to North, or any other reference direction –for example, the bow of a boat.

There are two arrows, a coloured rectangle, and an alignment notch to aid alignment.

See Figure 3 p.21 (Alignment & Mounting Details)



It is usually simpler to work first with a compass at ground level and identify a suitable landmark and its bearing.

5.3 Mounting



The support tube requires three 3 equally spaced holes, tapped M5, 7.5mm from the top of the tube. Pass the cable (fitted with the 9-way Clipper plug) through the tube. See Fig 3 p.21



The customer must fit appropriate strain relief to the cable.

Connect the plug by twisting it whilst pushing it gently into the socket on the WindSonic. When it locates, twist the outer sleeve clockwise to connect and lock the plug.

Fix the WindSonic to the tube using the 3 stainless steel screws provided. (Maximum mounting screw torque 1.5 Nm for aluminium and 3 Nm for stainless steel.)

It is the responsibility of the customer to ensure that the WindSonic is mounted in a position clear of any structure, which may obstruct the airflow or induce turbulence.



Do NOT mount the WindSonic in close proximity of high-powered radar or radio transmitters. A site survey may be required if there is any doubt about the strength of external electrical noise.

Mounting Bracket (1771-PK-115)

Mount the Sensor on to the bracket mount and if using a Wind Sensor align so that the Sensor North Marker points to the bracket pole.

Secure the sensor to its mount using screws and washers supplied in the Sensor Box.

Torque screws to a maximum of 4 Nm.

The Bracket uses a clamp suitable for attaching to a vertical pipe with a diameter of 30-58mm. When mounting the Bracket Sensor, consider the position, orientation, and alignment of the unit. Mount at the top of a Pipe to ensure a clear unobstructed measurement view.

Note that the mounting pipe should first be degreased and when assembling the Bracket clamp assembly, the outer clamp nuts need to be tightened evenly to a torque figure of 3 Nm.

The moving plate part of the clamp needs to be reversed for poles below 38 mm diameter.

Screw an Earth cable minimum of 6mm² to the Bracket chassis using Screw and Terminal Tag fixings supplied.

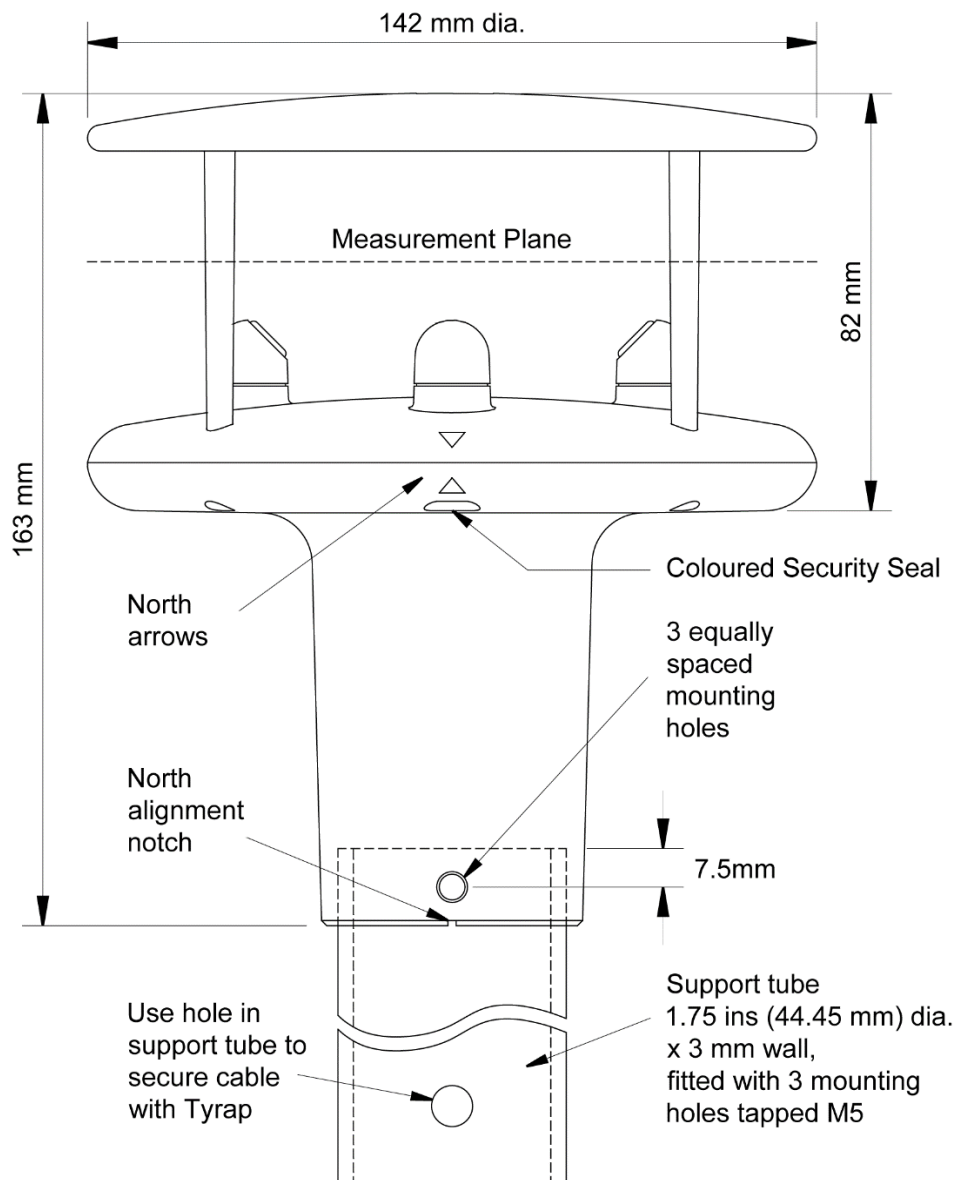

Gill Instruments can supply a 0.5 metre Aluminium support tube with drilled and tapped M5 holes as above, part number 1405-30-056.

Figure 3 Alignment & Mounting details

6 Message Formats

On applying power to the WindSonic, it will provide wind measurements in one of the following formats:

- Gill – Polar, Continuous (**default format**)
- Gill - UV, Continuous
- Gill – Polar Polled
- Gill – UV Polled
- NMEA – IIMWW or WIMWW (with NMEA status Codes)
- NMEA - IIMWW or WIMWW (with Gill Status Codes)
- Tunnel – U Direction, U Speed

Each of these is described below.

Information on how to change the formats and settings follows in Appendix E (CONFIGURING)

6.1 Gill format– Polar, Continuous (Default format)

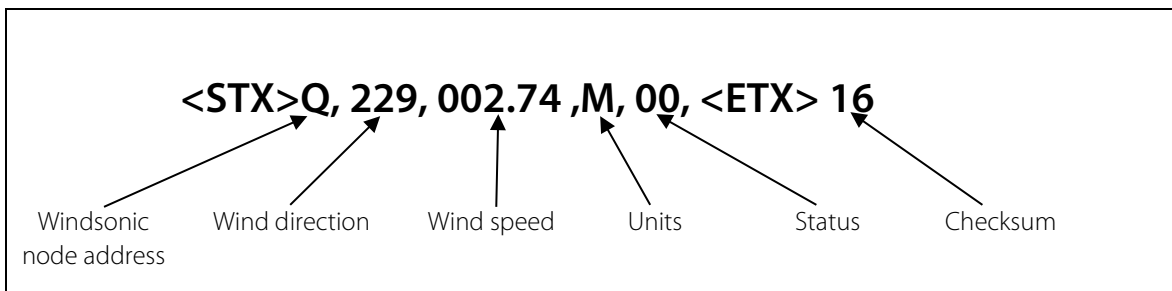

Where:

<STX>	=	Start of string character (ASCII value 2)
WindSonic node address	=	Unit identifier
Wind direction	=	Wind Direction
Wind speed	=	Wind Speed
Units	=	Units of measure (knots, m/s etc.)
Status	=	Anemometer status code (<i>see Appendix J for further details</i>)
<ETX>	=	End of string character (ASCII value 3)
Checksum	=	This is the EXCLUSIVE – OR of the bytes between (and not including) the <STX> and <ETX> characters.
<CR>	=	ASCII character
<LF>	=	ASCII character

WindSonic node address

The default setting is 'Q'. If required the WindSonic can be configured to show a different alphabetical node letter (A to Z), so as to identify the WindSonic.

It is recommended that ID's A to F and K, M, N and P are not used, as these characters can be present in the data string.

Wind Direction

Indicated in degrees, from 0 to 359°, with respect to the WindSonic North marker.

Whilst the wind speed is below 0.05 metres/sec (K50), then in Comma Separated Variable mode no direction value will be output (e.g. Q,,000.03,M,00,1C). In Fixed Field mode wind direction output will freeze at the last known valid direction value (e.g. Q,133,000.02,M,00,1A) until a new valid value can be calculated.

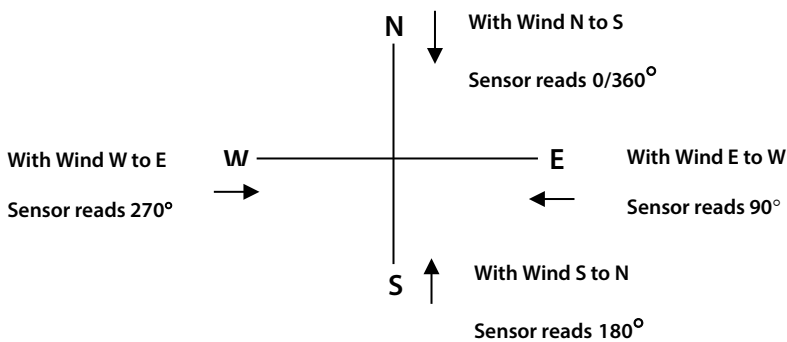

Wind speed and units

Shows the Wind Speed in the Measurement Plane (See Figure 3 above Alignment & Mounting details) in one of the following units:

Units	Identifier
Metres per second (default)	M
Knots	N
Miles per hour	P
Kilometres per hour	K
Feet per minute	F

Low Wind Speeds (below 0.05ms)

Whilst the wind speed is below 0.05 metres/sec, the wind direction will not be calculated.

In CSV mode no direction value will be output (e.g. Q,000.03,M,00,1C). In Fixed Field mode wind direction output will

freeze at the last known valid direction value (e.g. Q,133,000.02,M,00,1A) until a new valid value can be calculated. The above applies with the K command set for K50. If K for instance is set for 100 then the above applies at 0.1m/s.

Status

This indicates either

Correct operation Code 00 and A (NMEA).

or Error codes *See Section Appendix J for explanation of codes.*

Checksum

This enables the host system to check that the data has been correctly received. This is the EXCLUSIVE – OR of the bytes between (and not including) the <STX> and <ETX> characters.

Output rate (not displayed)

The WindSonic samples continuously and delivers wind information at ¼, ½, 1 (default setting), 2, or 4 outputs / second.

6.2 Gill format – UV, Continuous

In this mode, the output is given as signed (i.e., positive, or negative) speeds along the 'U' (= South – North) axis and the 'V' (= East – West) axis.

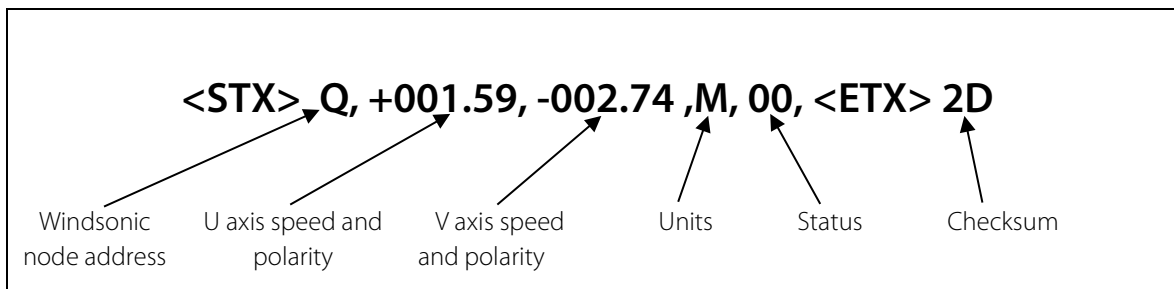

Where:

<STX>	=	Start of string character (ASCII value 2)
WindSonic node address	=	Unit identifier
U axis	=	speed & polarity
V axis	=	speed & polarity
Units	=	Units of measure (knots, m/s etc.)
Status	=	Anemometer status code (<i>see Appendix J for further details</i>)
<ETX>	=	End of string character (ASCII value 3)
Checksum	=	This is the EXCLUSIVE – OR of the bytes between (and not including) the <STX> and <ETX> characters

The WindSonic unit identifier, Units, and Checksum are as described in Section 0 above.

Figure 5 shows the polarity of U and V if the wind components along the U and V axis are blowing in the direction of the respective arrows.

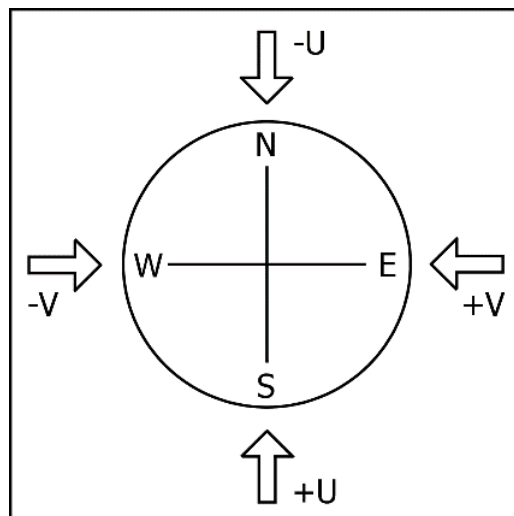
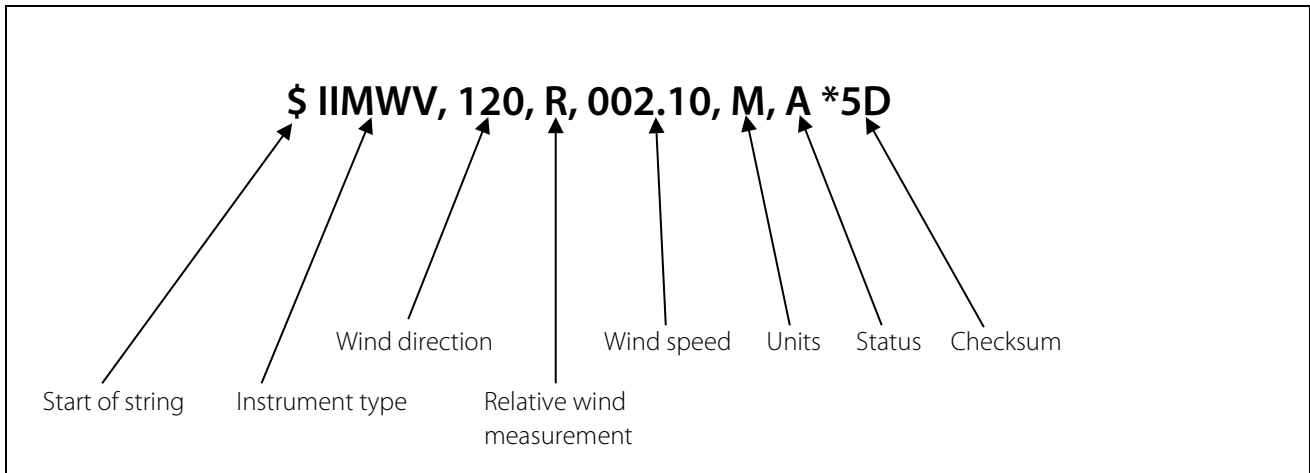

Figure 5 UV Polarity

6.3 NMEA Format (NMEA status codes)



The **Wind Direction**, **Wind Speed**, and **Units** are as described in Section 6.1.

The **Instrument Type** – IIMWV - is a mnemonic for Integrated Instrument Mean Wind direction & Velocity (alternative start of string format WIMWV can be selected).

The **Gill Status** codes are as described in Appendix J

A typical WindSonic configuration suitable for NMEA (See Appendix E)

M5, U1, O1, L1, P1, B3, H1, NQ, F1, E2, T1, S4, C2, G0, K50

Consult specification NMEA 0183 version 3 (available on the web) for complete interface details.

The WindSonic can also be set for the alternative start of string NMEA format WIMWV (Mode 14, which is a Mnemonic for:

Wind Instrument Mean Wind direction and Velocity.

The string format will appear as above but with WIMWV at the start of the string.

6.4 NMEA Format (Gill status codes)

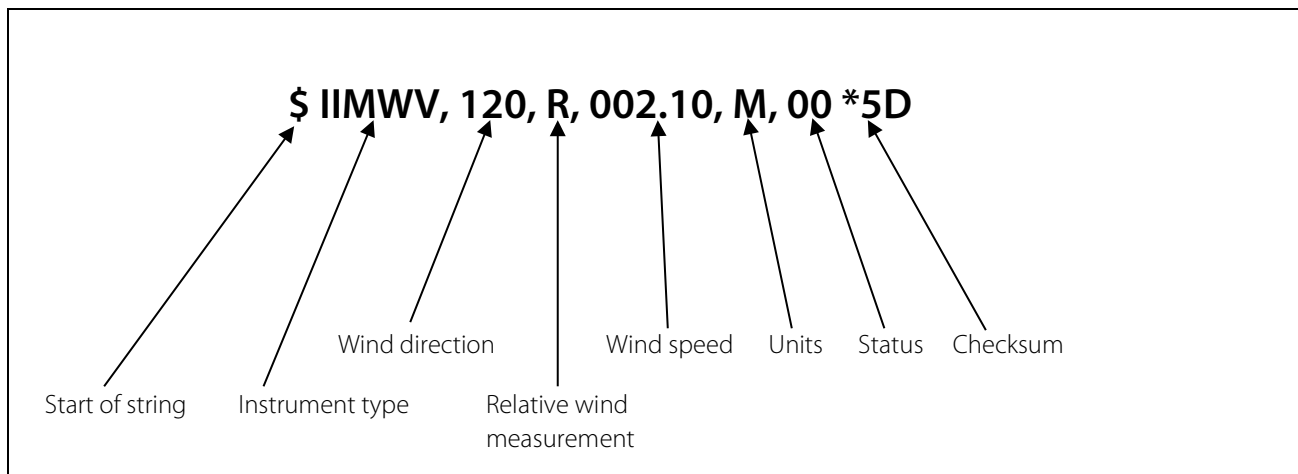

The **Wind Direction**, **Wind Speed**, and **Units** are as described in Section 6.1.

The **Instrument Type** – IIMWV - is a mnemonic for Integrated Instrument Mean Wind direction & Velocity (alternative start of string format WIMWV can be selected).

The **Gill Status** codes are as described in Appendix J.

A typical WindSonic configuration suitable for NMEA (Appendix E)

M16,U1,O1,L1,P1,B3,H1,NQ,F1,E2,T1,S4,C2,G0,K50

Consult specification NMEA 0183 version 3 (available on the web) for complete interface details.

6.5 Gill format – Tunnel Mode (UU, Continuous)

In this mode, the output is given as a signed figure (i.e. positive or negative) along the 'U' (= South – North) axis.

Direction is indicated by a 0 or 1.

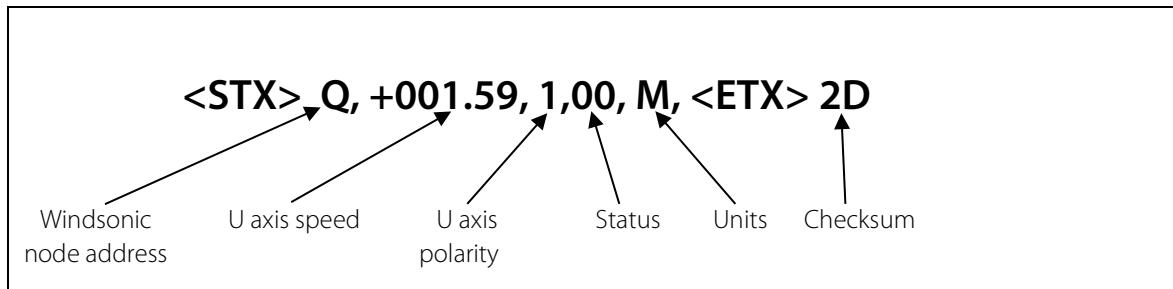

Where:

<STX> = Start of string character (ASCII value 2)

WindSonic node address = Unit identifier

U axis = U axis Wind Speed

U axis U axis Wind Direction Polarity where: -
0 (-U vector) is a wind from the North direction or
1 (+U vector) is a wind from the South direction.

See Section 6.1 for other string information.

6.6 Analogue Outputs and Options



Analogue outputs are only available from WindSonic Option 3.

Analogue Wind Speed output is in Metres/Second only.

6.6.1 Voltage or Current output

The WindSonic (Option 3) can be configured for either Voltage (0 – 5 V) or Current (0 –20mA and 4 – 20 mA) outputs.



1. When using the current outputs, the load resistance between the Analogue outputs (Pins 8 & 9) and Signal Ground (Pin 1) must be ≤ 300 ohms, including cable resistance.
This is to ensure that the voltage levels on Pins 8 & 9 do not exceed 5V.
2. The current outputs must be returned to Signal Ground (Pin 1).

6.6.2 Analogue Output Modes

Analogue Outputs	Polar Mode Modes 2 and 4	NMEA Mode Modes 5,14,15 &16	UV Mode Modes 1 and 3	Tunnel Mode Mode 12
Channel 1 (Pin 8 wrt Pin 1)	Wind Speed	Wind Speed	U Wind Speed	U Wind Speed
Channel 2 (Pin 9 wrt Pin 1)	Wind Direction	Wind Direction	U Wind Polarity	U Wind Polarity

6.6.3 Polar mode direction wraparound

The Wind Direction in Polar mode can be configured for either Standard (0 - 359°) or Wraparound (0 - 539°) options. If the Standard mode is used with a chart recorder, large swings of the recorder pen will be experienced each time the wind direction passes between 0 and 359°. Using the Wraparound mode, when the wind first changes from 0° to 359°, there will be a step change on the output, but after this first time the output will change smoothly each time the wind passes through 360°. (Similarly, the first time the wind veers from 539° to 180°; there will be a step change, after which the output will change smoothly).

Wind Direction (degrees)	Voltage Output (0v to 5V)		Current Output (0mA to 20mA)		Current Output (4mA to 20mA)	
	Standard	Wraparound	Standard	Wraparound	Standard	Wraparound
0	0	0	0.00	0.00	4.00	4.00
180	2.5	1.67	10.00	6.67	12.00	9.33
360	5.0	3.33	20.00	13.33	20.00	14.67
540	N/a	5.0	N/a	20.00	N/a	20.00

6.7 Wind Speed scaling

Analogue Outputs are always scaled in m/s irrespective of the digital output units of measurement setting.

The Wind Speed output can be configured such that full-scale output represents 5, 10, 20, 30, 40, 50, 60 (or 80 on Windsonic 75) metres/sec.

In all cases zero Wind Speed is represented by 0V, 0mA or 4mA.

6.8 Tunnel mode

When configured in Tunnel mode, Channel 1 output represents the wind speed along the U axis (South – North) scaled as described above.

Channel 2 gives the direction of the wind along the U axis, where a –U vector (= wind from the N direction) is represented by 0V (or 0mA, 4mA), and a +U vector is represented by 5V (or 20mA).

6.9 Analogue Output rate

In Continuous and Polled modes, the analogue output update rate will be determined by the P command setting.

6.10 Disabled outputs

If the analogue outputs are not required, they can be disabled (Command S9).

6.11 Analogue Output Conditions

Analogue signals are output together with Digital Outputs signals.

Analogue signals are output continuously when in Digital Polled Mode.



The WindSonic provides the power for current output loads. Do not connect the WindSonic output to instruments where power for the current loop is provided by the instrument connecting to the WindSonic current output connections.

6.12 Analogue Output Conditions

Whilst the wind speed is below 0.05 metres/sec, the wind direction will not be calculated.

In both CSV mode and in Fixed Field mode, Channel 2 wind direction output will freeze at the last known valid direction value until a new valid value can be calculated.

The above applies with the K command set for K50. If K for instance is set for 100 then the above applies at 0.1m/s.

Wind Speed Condition	Channel 1 Speed Output	Channel 2 Direction Output
Greater Than 0.05m/s	0-5v, 0/4 – 20mA variable	0-5v, 0/4 – 20mA variable
Less Than 0.05m/s	0-5v, 0/4 – 20mA variable	Hold last known good reading above 0.05m/s speed until wind speed increases above 0.05m/s

6.13 Error condition reporting

In both CSV and Fixed Field Modes, if a valid wind measurement cannot be calculated due to a fault condition (for example all paths blocked), the Analogue outputs on Channels 1 and 2 can report a digital error status condition depending on the Y command setting.



The Y command is not applicable to WindSonic 75 Analogue output units. WindSonic 75 units will report Error conditions as though set for Y1 below.

Y1 setting (Default).

Under data error conditions will switch back and forth between 0 and 5V (or 0/4 to 20mA) at the selected output rate.

The following table summarises the above reporting conditions with Analogue Outputs set for Polar Continuous Output and 0-5v (T1), 0-20mA (T5) and 4-20mA (T3).

Wind Speed Condition	Channel 1 Speed	Channel 2 Direction
Digital Error Code Output e.g. 01, 02, 04 etc.	Cycle 0 – 5 – 0 v at output rate	Cycle 0 – 5 – 0 v at output rate
	Cycle 0 – 20 – 0 mA at output rate	Cycle 0 – 20 – 0 mA at output rate
	Cycle 4 – 20 – 4 mA at output rate	Cycle 4 – 20 – 4 mA at output rate

Y2 nnn Setting, User Set Fixed Analogue Output level in an error mode.

The unit will output a fixed Voltage (T1 setting) or fixed milli-amp (T5/T3 settings) signal on the analogue output with a value depending on the Y2 nnn setting.

nnn is user-selectable value between 000 to 200.

Scale factor for fixed voltage output is 0.025V.

Scale factor for fixed current output is 0.1mA.

Therefore: -

nnn value = Required fixed Error Voltage/0.025 (voltage output setting T1).

nnn value = Required fixed Error Current/0.1 (current output settings T5/T3).

Under data error conditions then by setting the unit for Y2 configuration the analogue outputs will read a user set error value for the period of the error condition as follows with the unit in Polar Continuous Output and 0-5v (T1), 0-20mA (T5) and 4-20mA (T3).

Wind Speed Condition	Channel 1 Speed	Channel 2 Direction
Digital Error Code Output e.g. 01, 02, 04 etc	Error Condition nnn x 0.025 v (T1 setting).	Error Condition nnn x 0.025 v (T1 setting).
	Error Condition nnn x 0.1mA. (T5 & T3 setting)	Error Condition nnn x 0.1mA. (T5 & T3 setting)

Y3 nnn setting Analogue Output cycles to a user determined level in an error mode.

Under data error conditions the analogue outputs will switch back and forth between a user determined level (voltage or current) with a value depending on the Y3 nnn setting.

nnn is user-selectable value between 000 to 200.

Scale factor for upper voltage output is 0.025V.

Scale factor for fixed current output is 0.1mA.

Therefore: -

nnn value = Required Error Voltage/0.025 (voltage output setting T1).

nnn value = Required Error Current/0.1 (current output settings T5/T3).

The following table summarises the above reporting conditions with Analogue Outputs set for Polar Continuous Output and 0-5v (T1), 0-20mA (T5) and 4-20mA (T3).

Wind Speed Condition	Channel 1 Speed	Channel 2 Direction
Digital Error Code Output e.g. 01, 02, 04 etc.	Cycle 0 – set v – 0 v at output rate	Cycle 0 – set v – 0 v at output rate
	Cycle 0 – set mA – 0 mA at output rate	Cycle 0 – set mA – 0 mA at output rate
	Cycle 4 – set mA – 4 mA at output rate	Cycle 4 – set mA – 4 mA at output rate

ERROR CONDITION REPORTING NOTES:

1. Y1, Y2 and Y3 settings are implemented in firmware version 2368-110-01 and onwards.
2. The Y command is not reported in the D3 string, a Terminal Program is used to set up the Y Command.
3. When setting Y2 or Y3 level note that there is a space character after Y2 or Y3 and before the nnn value e.g., Y2 150.

For instance, if the unit is set for 0-5v analogue outputs and it is required to report a fixed voltage level of 3.75v under error conditions (Y2 150) then: -

Open a terminal program (e.g., HyperTerminal, Tera Term or Gill Wind Software (Wind Wizard not applicable)) at the matching COM Port connection and Baud rate.

Type * to place the unit into CONFIGURATION MODE.

Type Y2 150 and press the Enter key.

Type Q and press Enter to return to Measurement Mode.

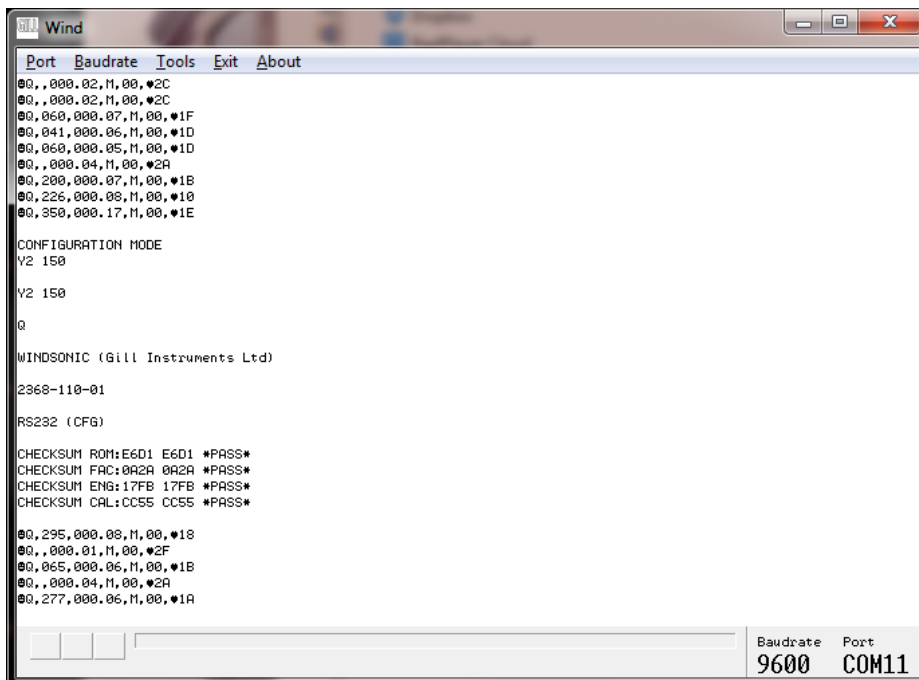

4. To check the Y settings then in Configuration Mode Type Y and press the Enter key and the unit will report Y1 or the full Y2 or Y3 setting e.g.

Y

Y2 0 (=Y2 000)

Y

Y2 1 (=Y2 001)

Y

Y2 10 (=Y2 010)

Y

Y2 100 (=Y2 100)

7. SDI-12 WindSonic

WindSonic option 4 SDI-12 is factory configured in SDI-12 mode and complies with SDI-12 Interface Standard V1.3, see Appendix F, SDI-12 Commands for details.

WindSonic Option 4 is not compatible with Gill Wind or WindView Software.

7.1. Cable Type

Application	No. of pairs	Gill ref.	Belden ref.	Batt electronics ref.
SDI-12	2	-	9729	-

7.2. Cable Length

WindSonic Option	Communication Format	Baud Rate	Max. Cable Length
Option 4	SDI-12	1200	90m (300ft)

7.3. Connecting to an SDI-12 Interface (Option 4)

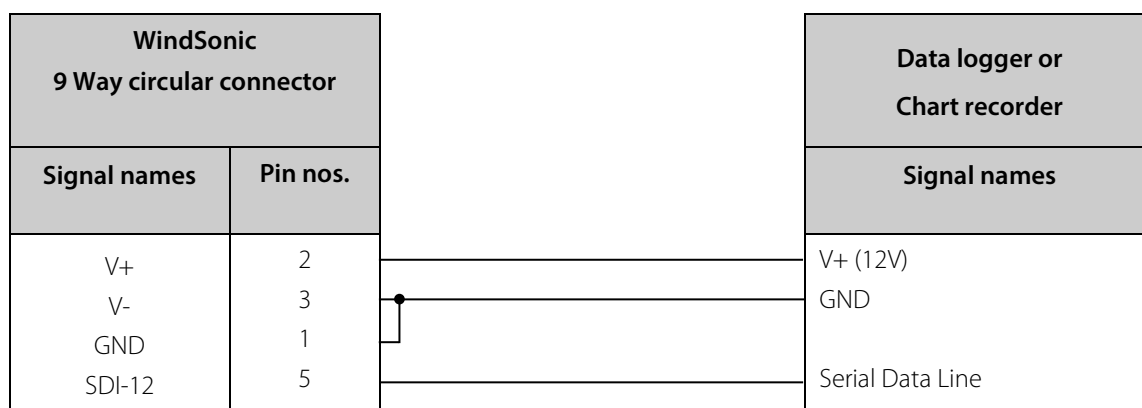

Appendix A - Technical Specification (Options 1, 2 & 3)

Wind Measurement		
Units of Measure	Metres/second (m/s, Knots, Miles per hour (mph), Kilometres per hour (kph), Feet per minute (fpm)	
Output Frequency	0.25, 0.5, 1, 2, or 4 outputs per second	
Parameters	Digital	Analogue
	Polar - Speed and Direction UV - 2 axis, signed Speed NMEA Speed and Direction Tunnel - U speed & U Polarity	Polar - Speed and Direction UV - U Speed and U Polarity NMEA - Speed and Direction Tunnel - U Speed & U Polarity
Wind Speed		
* Values are dependent on anemometer being used		
Range	0 – 60m/s WindSonic 0 -75m/s WindSonic 75	0 – 5m/s, 0 – 10m/s, 0 – 20m/s, 0 – 30m/s, 0-40m/s, 0 – 50m/s, 0 – 60m/s, 0-80m/s.
Accuracy Resolution	± 2% RMSE (at 12m/s) 0.01 m/s	± 2% RMSE (at 12m/s) 10 bits
Analogue output formats 0-5V 4-20mA 0-20mA	± 1% of full-scale N.B. Analogue output impedance = 1KΩ (V out) Load resistance between the Analogue outputs (Pins 8 & 9) and Signal Ground (Pin 1) must be ≤ 300 ohms, including cable resistance.	
Wind Direction		
Range	0-359 Degrees	0 - 359° Or 0 - 539° (Wraparound mode)
Accuracy Resolution	± 2° (at 12m/s) 1°	± 2° (at 12m/s) 1°

Digital Output Formats	
Gill	Continuous or Polled (output on request by host system) Polar (Speed and Direction) or UV (2 axis, signed Speed)
Marine - NMEA	NMEA 0183 version 3
Power Supply	
Input voltage	5 to 30 V DC Option 1 and 2 units (WindSonic) 7 to 30 V DC Option 3 units (WindSonic)
Current at 12v	Current requirement depends on variant i.e. RS232 approximately 9mA rising to 44mA for Analogue variant. Lowest power consumption is obtained with the following configuration: - M2, P20, B3, S9 (approximately 5.5mA at 12v). 12 – 30 V DC Option 1, 2 and 3 units (WindSonic 75) Current drain i.e., RS232 approximately 13mA at 12v DC.

Environmental	
Protection Class	IP66
EMC	EN 61326
Operating Temperature	-35°C to +70°C
Storage Temperature	-40°C to +80°C
Operating Humidity	<5% to 100%
RoHS Compliant	Yes
Standards	Manufactured within ISO9001: 2008 quality system

Mechanical	
External Construction	External - Acrylate Styrene Acrylonitrile, Polycarbonate blend
Mounting	Pipe mounting 1.75 inches (44.45mm) diameter
Weight	0.5kg
Size	142mm diameter x 163mm

Software	
Wind	Free PC Software to set-up Windsonic
WindView	Free PC Software to view and log Windsonic data

WindSonic Option 4 Specification

Output	
Units of measure	Metres/second (m/s)
Wind Speed	
Range	0 – 60 m/s
Accuracy	± 2% RMSE (at 12m/s)
Resolution	0.01 m/s
Wind Direction	
Range	0 - 359°
Accuracy	± 2° (at 12m/s)
Resolution	1°
Digital output formats	
Digital Data	SDI-12 V1.3
Averaging	1 Minute Vector, 1 Minute Scalar, 1 Minute Maximum Speed
Anemometer status	Status OK and Error codes included as part of standard output message
Environmental	
Moisture protection	IP66
Temperature	Operating -35°C to +70°C
Humidity	Operating <5% to 100%
EMC	EN 61000-6 - 3 (Emissions) EN 61000-6 - 2 (Immunity)
Standards	Manufactured within ISO9001: 2008 quality system
Power requirement	9.6 – 16 V DC. Current drain <2mA @12v low power operation Current drain <10mA @12v high power operation
Mechanical	
Size	diameter 142mm x 160mm
weight	0.5kg
Mounting	Pipe mounting 1.75 inches (44.45mm) diameter
Material	External - Acrylate Styrene Acrylonitrile, Polycarbonate blend.

Appendix B - Cable Assembly

Preparation.

Open the pack of parts provided with the WindSonic or as part 1405-PK-069.

Note that the connector supplies the correct strain relief for cables with an outside diameter of 6-12mm).

Trim back the screened cable outer and screen sleeves 40mm.

Trim back the screen drain wires flush with the outer sleeve.

Strip back the connection wires by 5mm.

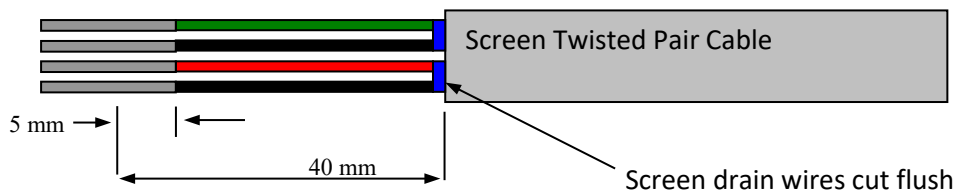

Soldering Contacts.

Note that the supplied size 20 contacts are suitable for wire gauges 20 AWG to 24 AWG.

Tin solder the stripped wires.

Solder the contact pins to the wires.

Crimping Contacts.

Note that the supplied size 20 contacts are suitable for wire gauges 20 AWG to 24 AWG.

Example crimp tools are: -

Daniels Manufacturing Corporation Tool AF8 and Turret TH1A.

https://www.dmctools.com/oscar/catalogue/af8_271/

https://www.dmctools.com/oscar/catalogue/th1a_3128/

or

Astro Tool Corporation Crimp tool 615708 and Turret 615709.

<https://www.astrotool.com/products/615708-m22520-1-01-crimping-tool-dmc-af8/>

<https://www.astrotool.com/products/615709-m22520-1-02-turret-head-dmc-th1a/>



Lightly twist the stripped wires (do not solder the wires).

Insert the wire into the supplied contact barrel and ensure that it can be seen through the contact inspection hole.

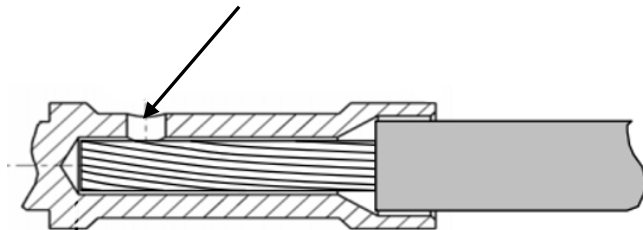

With the crimp tool fully open place the contact and wire into the crimp tool barrel.

Fully close the crimp tool allowing it to re-open on its own.

Visibly check that the wire is visible through the inspection hole.

Connector Assembly.



To disassemble the connector, reverse this procedure

Put the parts on the cable in the order as shown below.



Whilst squeezing the red retainer in the direction of ARROWS A, pull in the direction of ARROW B

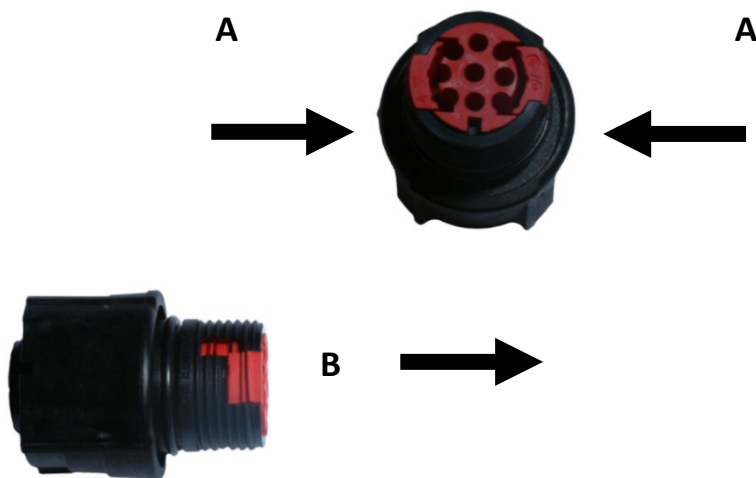

Your connector should now resemble the connector in the picture below.



Insert each contact pin until you feel a slight click. If you have inserted the contact into the incorrect hole it can be removed at this point by simply pulling it out. Please note there will be some resistance.

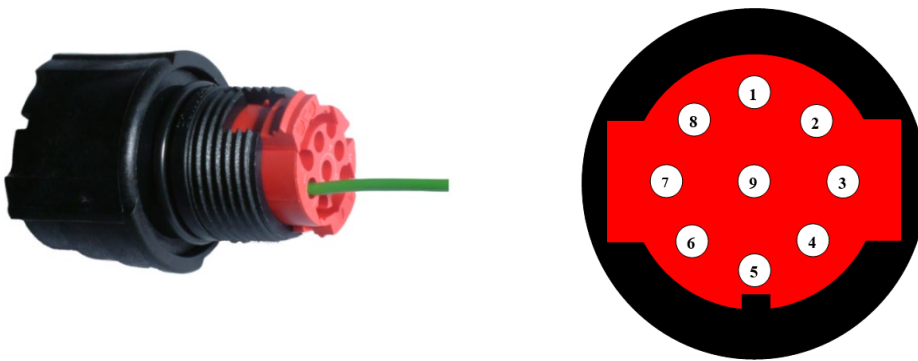

Rear View of Connector

Continue to insert all of the contacts you require. Once all of the contacts are inserted push the red retainer into place. NB. The retainer can only be pushed back into place if the contacts are fully engaged.



Fit the connector to the WindSonic so that you can finish assembling the connector.



Screw the back shell onto the connector until it is fully in place. Please note that the final rotations can be slightly stiff.



Now screw the next part of the connector into place.



Now screw the cable-clamping nut into place.



The connector can now be removed from the WindSonic.

Connector Spares

For spares purposes the complete WindSonic Souriau Clipper connector comprises of: -

9-way Connector	CL1F1201.
Connector female contact	CM10SC10MQ (size 20 contact).
Sealing Gland Clipper size1	CL101021 (suitable for cables 6-12mm outer diameter).

Appendix C - WindSonic Default Setup

The **WindSonic Option 1** unit is factory configured with the following default settings:

M2, U1, O1, L1, P1, B3, H1, NQ, F1, E3, T1, S4, C2, G0, K50,

The **WindSonic Option 2 and 3** unit is factory configured with the following default settings:

M2, U1, O1, L1, P1, B3, H1, NQ, F1, E2, T1, S4, C2, G0, K50

See Section Appendix E for further details

Notes

WindSonic Option 1 set for RS232 mode (E3, default)

WindSonic Options 2-3 to be set for RS422/RS485 mode (E2, default).

WindSonic Option 4 be set for SDI-12 only.

Analogue Outputs are also simultaneously available from the **Option 3** unit.



WindSonic Option 4 is not compatible with Gill Wind or WindView Software.

Appendix D - Windsonic Safe mode

Using Safe Mode to get communication and to change settings

If an option 1, 2 or 3 unit is not communicating an output then try the Safe Mode feature as detailed following (please note that power connections are reversed from diagram for Option 1 model).

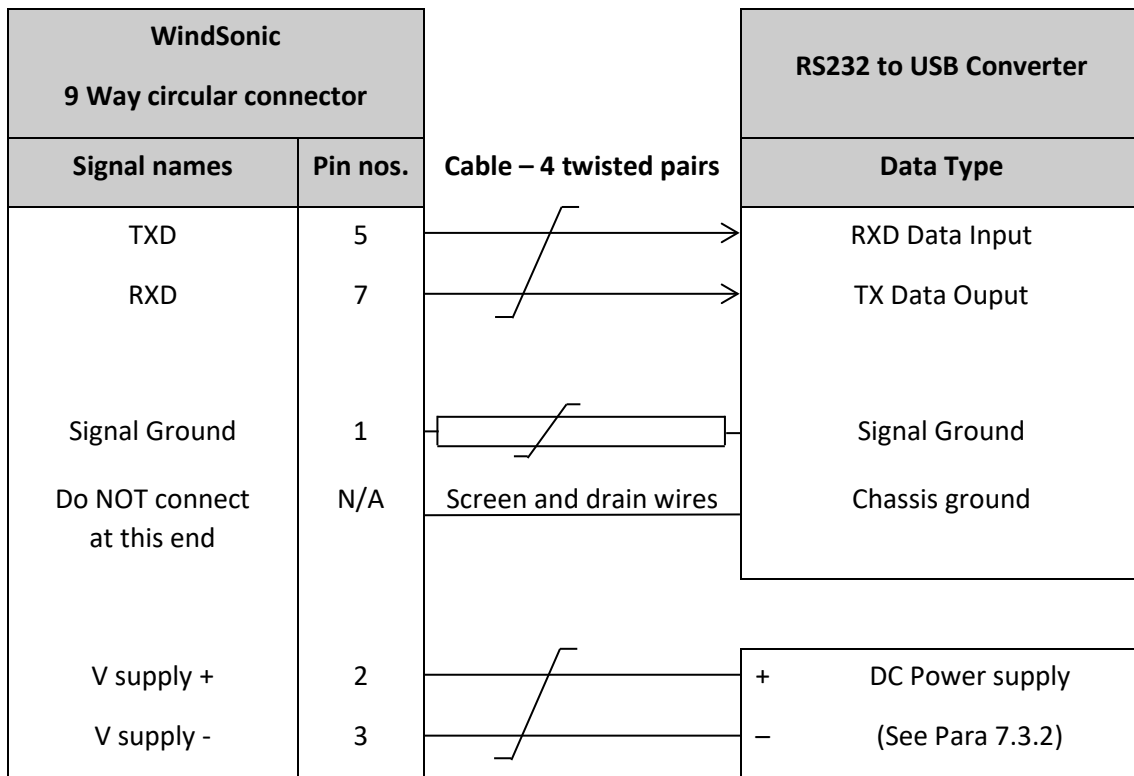

In the event the unit is not communicating in SDI-12 mode a unit check may be made in RS232 safe mode for fault finding purposes (**applies to units with serial number 11220007 and higher**).

Wire the SDI-12 WindSonic as follows: -

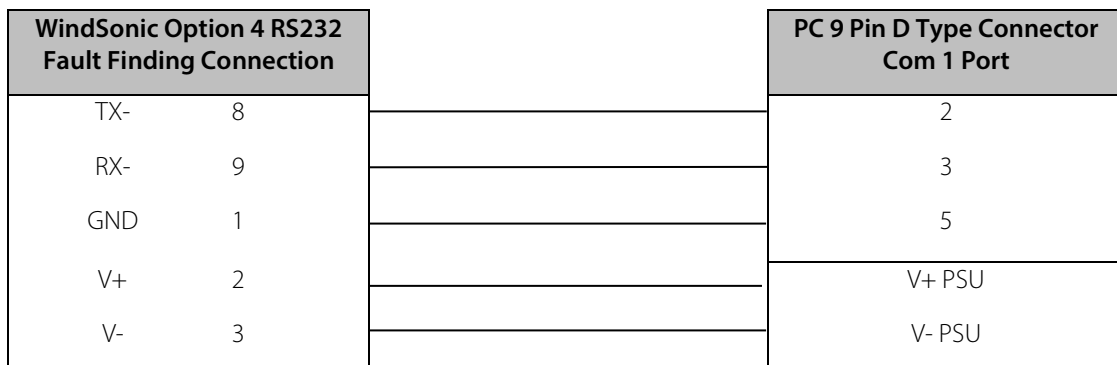



Operation Method Summary.

Connect the Option 1, 2, 3 or SDI-12 WindSonic as per the previous connection diagrams.

With WindSonic power off, set up a Terminal connection **but with the Baud rate set to 19200 (this can be at variance with the original WindSonic Baud rate setting).**

Hold down the * character (shift 8) and apply power to the WindSonic. After approximately 3 seconds the unit will respond with **Safe Mode**.

Remove any * characters on screen or press the Enter key.

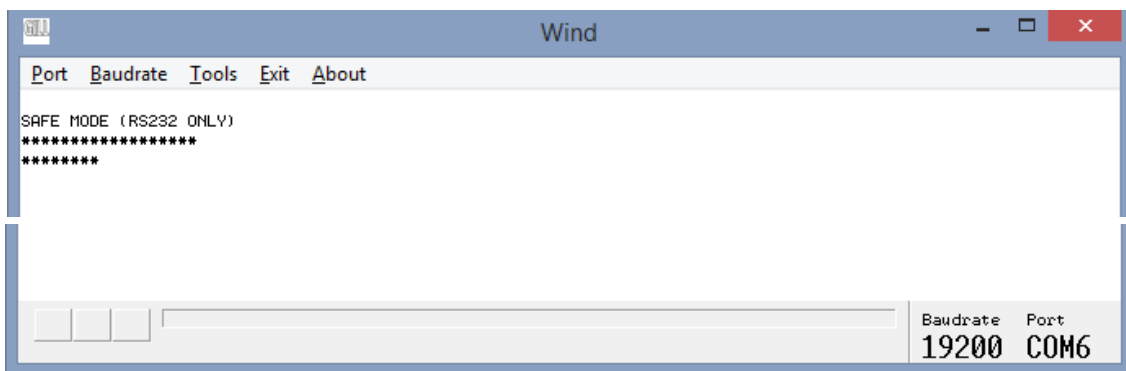

To check the current configuration settings Type D3 and press the Enter key.

To change any setting type in the appropriate command and then press the Enter key.

Type Q and press Enter to return to Measurement mode.

Turn off/on the unit to return to normal operation, note that comms may now be lost with the safe mode connection.

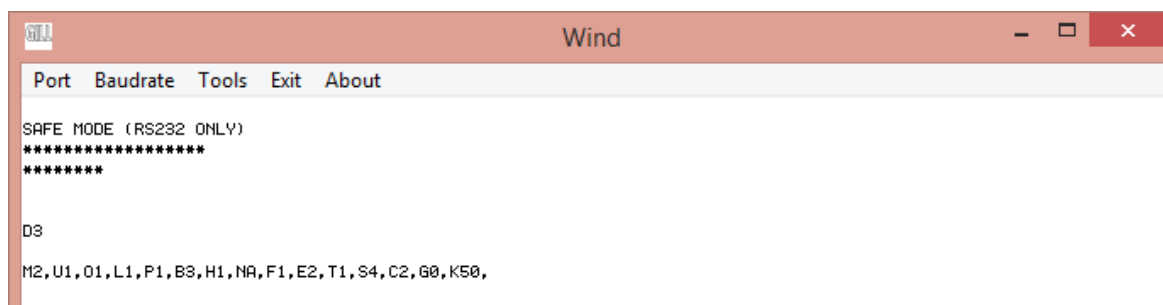



Not applicable for option 1 Windsonic

To Change the Communication setting from a unit set for RS422 to RS232 when in safe mode: -

Type E3 and press the Enter key.

If the change is successful, then another E3 will be shown.

Type D3 and press Enter to confirm if required.

Turn off/on the unit to return to normal operation, change the Wind Software baud rate setting to match that of the WindSonic to view data.

```
Wind
Port Baudrate Tools Exit About
SAFE MODE (RS232 ONLY)
*****
*****
D3
M2,U1,01,L1,P1,B3,H1,NA,F1,E2,T1,S4,C2,G0,K50,
E3
E3
D3
M2,U1,01,L1,P1,B3,H1,NA,F1,E3,T1,S4,C2,G0,K50,
```



Only applicable to SDI-12 units

If commands are typed (followed by the Enter key) that the unit will not accept, then ILLEGAL COMMAND LINE will be reported.

Commands that will be accepted are: -

REPORT then press Enter key (see below).

SERIAL then press Enter key (see below).

SWVER then press Enter key (see below).

Type Q then press Enter key (see below) this allows data to scroll on screen.

The Wind data string can be examined to check for instance that the wind direction and speed are output, and the 2-digit status code is 00.

If the 2-digit Status Code is other than 00 refer to Appendix J.



Once the unit is turned off and back on again it will return to SDI-12 mode.

If you need to get back into Gill continuous data, then you have to perform the safe mode steps again.



Power to the WindSonic is turned off at this stage.

Open a Terminal Program e.g., Tera Term or HyperTerminal etc.

The Safe Mode settings are:

Baud Rate	4800
Data bits	8
Parity	None
Stop bits	1
Flow Control	None

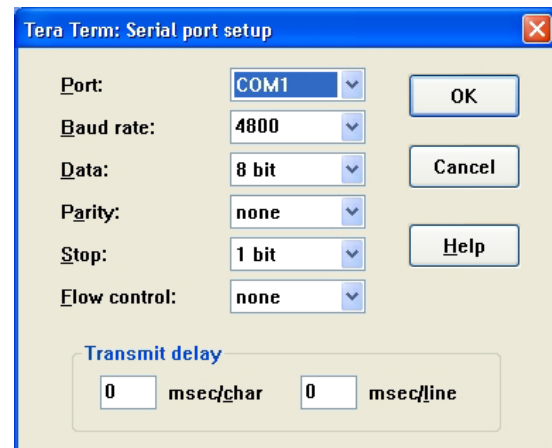

Appendix E - Configuring

Gill Wind Software may be used to configure the WindSonic; alternatively, the user may elect to use another terminal emulator package such as Tera Term or puTTY etc. This section describes the commands used to change User and Communications settings.

Wind

Wind software is available to download, free of charge, from the Gill Instruments Limited website <http://gillinstruments.com/main/software.html>.

Wind software allows the unit configuration to be changed and to be able to display the Digital Data String on a PC screen.

NOTE: Wind is not compatible with WindSonic Option 4 – SDI-12 or WindSonic units prior to serial number 08100001 with a yellow or blue tab adjacent to the North Marker.



Connect both WindSonic transmit and receive data lines to the PC to establish 2-way communications.

Open Wind Software and select the appropriate Com Port from the drop-down menu and click on OK to reach the data screen.



If data is not correctly displayed, then on the Menu click on Tools/Synch Comms.

The Sensor will be interrogated, and Sensor Baud Rate and Mode settings detected and reported.

Wind software settings will be adjusted to match those of the sensor to show data scrolling on screen.

If after Synch Comms there is still a problem, repeat Synch Comms or switch off the sensor and switch back on again and repeat above procedure.



It is also possible to use Wind as a Terminal Program and change settings using the Configuration Mode of operation (Commands are listed on pages 57-64, Appendix E)

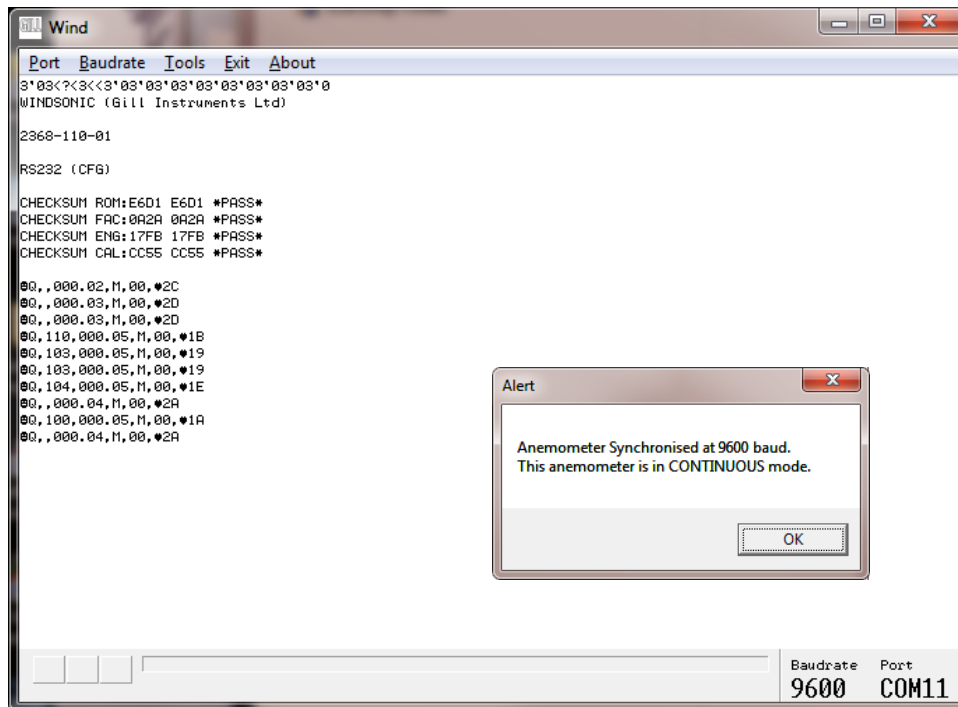

If you wish to review the Sensor Settings, click on **Tools/Report Config**.
When selected a similar message to that below will be seen.

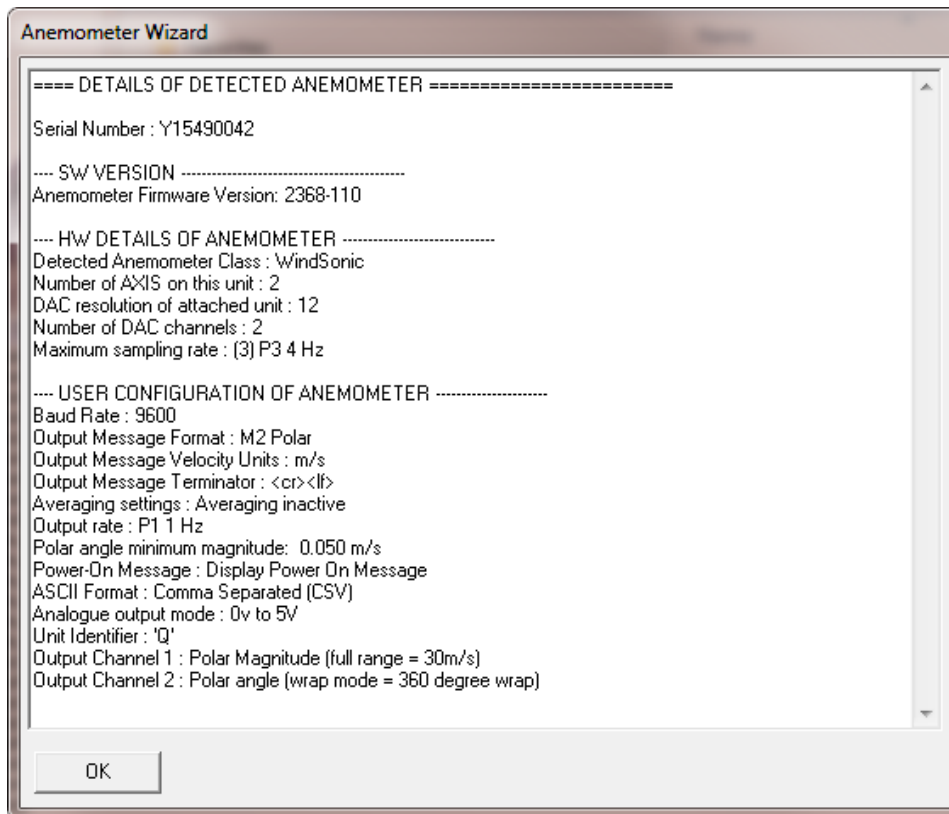

To review and change the WindSonic configuration click on **Tools/Wizard**

Typical Screen is shown following: -

The screenshot shows the 'Anemometer Wizard' configuration window. It contains several sections of settings:

- Message Output Format:** M2 Polar
- Baud Rate:** 9600
- Output Rate:** P1 1 Hz
- Message Terminator:** <cr><lf>
- Measurement Units:** m/s

- Alignment:** (empty dropdown)
- Averaging (0 = Off):** 0
- Resolution:** (empty dropdown)
- Direction Reporting Threshold:** 50
(minimum magnitude for polar angle reporting)

- SOS/Sonic Temp Display:** (empty dropdown)
- Display Analogue Inputs:** (empty dropdown)
- Analogue Output Mode:** 0v to 5V
- PRT setting:** (empty dropdown)

- Unit Identifier:** Q
- Power on Message:** Display Power On Messag
- Retries Enabled
- Instantaneous Sampling
- Calibration Enabled

- ASCII Format:** Comma Separated (CSV)

- DAC Channel 1:** (empty dropdown) (empty dropdown)

Buttons: Next > Cancel

To change a setting i.e., change from M2 (Polar) to M1 (UV), select M1 from the Wizard drop down list then click on Next.

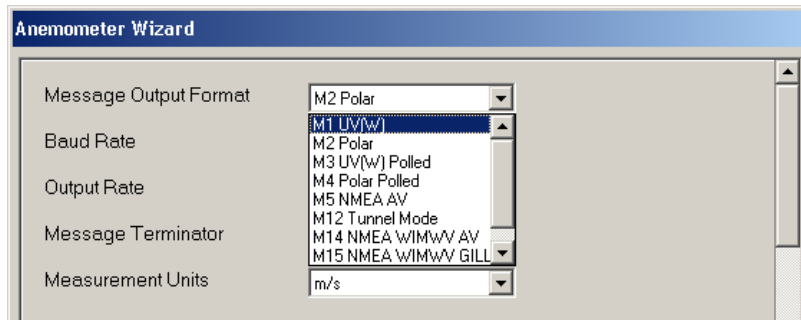

The following screen will show settings that will be changed.
Then click on Next.

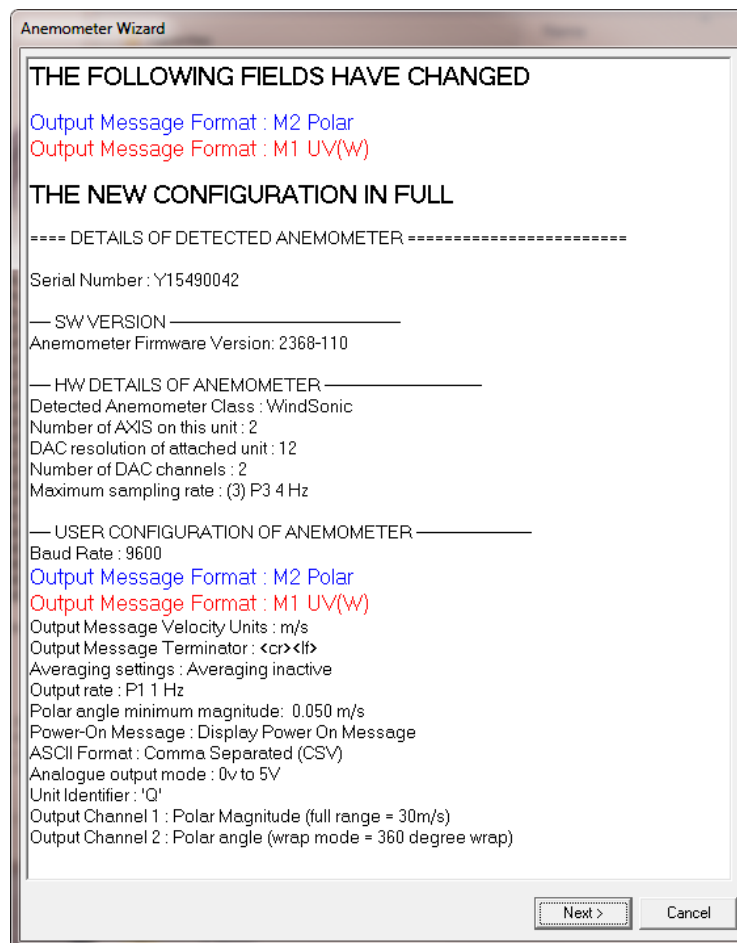

Wind will report Setting up Anemometer and then re-start the anemometer scrolling data in UV mode.



Note: - It is also possible to change settings in Wind using the Configuration Mode of operation. (Commands are listed on pages 57-64) (Appendix E)

Configuring using terminal package



1. Determine the COM port the WindSonic is connected to.
2. Open preferred terminal program (Wind, Tera Term etc.)
3. Select COM port
4. Adjust the Port settings to match WindSonic settings. WindSonic default settings are :

Bits per second 9600

Data bits 8

Parity None

Stop bits 1

Flow Control (Handshaking) None

Click on OK and data similar to the following example will scroll on screen at the output rate:

☺ Q, 229, 002.74, M, 00, ♥ 06

Entering Configuration mode

From Continuous mode

Type *****

From Polled mode

Type ***** then **<N>**

Where <N> is the Unit identifier

The WindSonic responds with a CONFIGURATION MODE message, stops reporting wind measurements, and waits for a command (as detailed below).

Returning to Measurement mode

Type **Q** then press **ENTER**

The WindSonic responds with a checksum test and then continuous wind information when in continuous mode, or on receipt of a Poll signal when in Polled mode.

Checking the Configuration

We recommend that, as a standard procedure, you use this command prior to and after changing any settings. It shows the current settings for all the alterable settings.

Type *****

Type **D****3** then press **ENTER**

The WindSonic responds with the default settings shown below for **Option 1 units**.

M2, U1, O1, L1, P1, B3, H1, NQ, F1, E3, T1, S4, C2, G0, K50

The WindSonic responds with the default settings shown below for **Option 2 and 3 units**.

M2, U1, O1, L1, P1, B3, H1, NQ, F1, E2, T1, S4, C2, G0, K50

We suggest you note down the settings, so that you can easily return to them.

To return to measurement mode: -

Type **Q** then press **ENTER**

All of the above settings are explained in the following sections.

Changing a setting

To change a setting, refer to the commands listed in Appendix E. Enter the command of the new setting required, followed by **ENTER**. The new setting will be sent as a message by the WindSonic.

For example, to change the message format to NMEA, Type **M****5** and press **ENTER**

The WindSonic will reply **M5**. When the unit is returned to the Measurement mode, it will be in NMEA format.



The factory-set (default) settings are shown in **bold** in the following sections.

To Change E Command setting refer to **Safe Mode** operation, Appendix D.

Appendix F – SDI-12 Commands

Gill Output Message Format

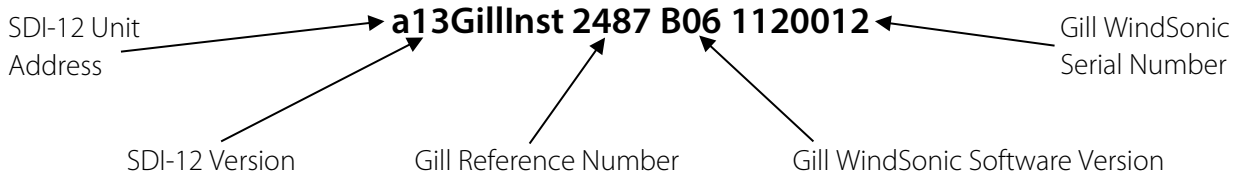

Under normal no error conditions a typical data output will show: -

0+083+000.02+00<CR><LF> e.g., Unit ID, Direction, Speed, Status Code.

Under error conditions e.g. blocked paths error code 04 the unit will pad the wind data with 9's as follows (Gill Fixed Field setting):-

0+999+999.9+04<CR><LF> e.g., Unit ID, Direction, Speed, Status Code.

WindSonic Option 4 complies with SDI-12 Interface Standard V1.3

We advise that you download the full SDI-12 specification from www.sdi-12.org

All other commands not defined below respond with a 'zero data values ready' response.

All units of measurement are in metres per second. This cannot be re-scaled.

Wind Measurements are made at 1Hz.

The default operating mode is aXHPM!.

The default unit address is 0 (a or A = unit address).

The unit is set for fixed field operation.

Commands and Returns in Low Power Mode (aXLPM!)

Note: - Rolling average data not available.

Use of the aR2!, aR3!, aR4! and aR5! (and their associated aRCn!) commands when the device is in aXLPM! (Low power - continuous) mode, will return a "zero data values ready" message.

Name	Command	Gill Output
Not Applicable	aR0!	Zero Data values ready e.g. 0<CR><LF>
Not Applicable	aRC0!	Zero Data values ready e.g. 0AP@<CR><LF>
Not Applicable	aR1!	Zero Data values ready e.g. 0<CR><LF>
Not Applicable	aRC1!	Zero Data values ready e.g. 0AP@<CR><LF>
Not Applicable	aR2!	Zero Data values ready e.g. 0<CR><LF>

Name	Command	Gill Output
Not Applicable	ARC2!	Zero Data values ready e.g. 0AP@<CR><LF>
Not Applicable	AR3!	Zero Data values ready e.g. 0<CR><LF>
Not Applicable	ARC3!	Zero Data values ready e.g. 0AP@<CR><LF>
Not Applicable	AR4!	Zero Data values ready e.g. 0<CR><LF>
Not Applicable	ARC4!	Zero Data values ready e.g. 0AP@<CR><LF>
Not Applicable	AR5!	Zero Data values ready e.g. 0<CR><LF>
Not Applicable	ARC5!	Zero Data values ready e.g. 0AP@<CR><LF>
Start Measurement (Polar)	aM!	atttn<CR><LF> e.g. a0053 Where a is unit identifier, 005 is measurement time in seconds and 3 is the number of data readings.
Send Data	aD0!	a<dir><mag><status><CR><LF> e.g. 0+083+000.02+00<CR><LF>
Start Measurement (UV)	aM1!	atttn<CR><LF> e.g. 00053
Send Data	aD0!	a<U><V><status><CR><LF> e.g. 0+000.00+000.02+00<CR><LF>
Start Measurement with CRC (Polar)	aMC!	atttn<CR><LF> e.g. 00053
Send Data	aD0!	a<dir><mag><status><CRC><CR><LF> e.g. 0+295+000.01+00B{T<CR><LF>
Start Measurement with CRC (UV)	aMC1!	atttn<CR><LF> e.g. 00053
Send Data	aD0!	a<U><V><status><CRC><CR><LF> e.g. 0+000.00+000.00+00JZY<CR><LF>
Acknowledge Active	a!	a<CR><LF> e.g. 0<CR><LF>
Send Identification	al!	a13GillInst 2487 B06 <sn><CR><LF> e.g. 013GillInst 2487B0611220012<CR><LF>
Change Address	aAb!	b<CR><LF> e.g. 1<CR><LF>
Address Query	?!	a<CR><LF> e.g. 0<CR><LF>
Measurement on demand	aXLPM!	0LP<CR><LF>
Continuous Reading	aXHPM!	0HP<CR><LF>

Commands and Returns in High Power Mode (aXHPM!)

When in high power continuous mode, Wind data (Polar or Axis format) will be logged internally at 1Hz such that a 1-minute rolling average and 1 minute maximum (with associated direction) can be retrieved at any time.

1 minute averaged outputs are available using aR2!, aR3!, aR4! and AR5! Commands.



When powering up the unit wait 9.5 seconds before sending a command.

Name	Command	Gill Output
Continuous Measurement (Polar)	aR0!	a<dir><mag><status><CR><LF> e.g., 0+332+000.04+00><CR><LF>
Continuous Measurement with CRC (Polar)	aRC0!	a<dir><mag><status><CRC><CR><LF> e.g., 0+272+000.02+00Ldg><CR><LF>
Continuous Measurement (UV)	aR1!	a<U><V><status><CR><LF> e.g., 0-000.03-000.01+00><CR><LF>
Continuous Measurement with CRC (UV)	aRC1!	a<U><V><status><CRC><CR><LF> e.g., 0+000.00-000.01+00DUx><CR><LF>
Averaged vector (UV) data converted to polar direction and magnitude. Scalar magnitude maximum and direction associated with that maximum	aR2!	a<dir_from_vectorav><mag_from_vectorav><dir_at_mag_sca larmax><mag_scalarmax><status><CR><LF>. e.g., 0+090+000.02+123+000.12+00><CR><LF>
Averaged vector (UV) data converted to polar direction and magnitude. Scalar magnitude maximum and direction associated with that maximum with CRC	ARC2!	a<dir_from_vectorav><mag_from_vectorav><dir_at_mag_sca larmax><mag_scalarmax><status><checksum><CR><LF> e.g., 0+090+000.02+123+000.12+00Hv <CR><LF>
U and V values from the averaged vector (UV) data. Scalar magnitude maximum and direction associated with that maximum converted into U and V components.	AR3!	a<U_vectorav><V_vectorav><U_from_scalarmax><V_from_sc alarmax><status><CR><LF> e.g., 0+000.00+000.02+000.07+000.10+00><CR><LF>

Name	Command	Gill Output
U and V values from the averaged vector (UV) data. Scalar magnitude maximum and direction associated with that maximum converted into U and V components with CRC	ARC3!	a<U_vectorav><V_vectorav><U_from_scalarmax><V_from_scalarmax><status><checksum><CR><LF> e.g. 0+000.00+000.02+000.07+000.10+00JMJ<CR><LF>
Scalar average direction and magnitude	AR4!	a<dir_scalarav><mag_scalarav><dir_at_mag_scalarmax><mag_scalarmax><status><CR><LF> e.g. 0+062+000.04+123+000.12+00<CR><LF>
Scalar average direction and magnitude with CRC	ARC4!	a<dir_scalarav><mag_scalarav><dir_at_mag_scalarmax><mag_scalarmax><status><checksum><CR><LF> e.g. 0+070+000.03+123+000.12+00JFr<CR><LF>
Scalar average direction and magnitude, then converted into U and V components.	AR5!	a<U_from_scalarav><V_from_scalarav><U_from_scalarmax><V_from_scalarmax><status><CR><LF> e.g. 0-000.01+000.03+000.07+000.10+00<CR><LF>
Scalar average direction and magnitude, then converted into U and V components with CRC.	ARC5!	a<U_from_scalarav><V_from_scalarav><U_from_scalarmax><V_from_scalarmax><status><checksum><CR><LF> e.g. 0+000.00+000.03+000.07+000.10+00EJ[<CR><LF>
Start Measurement (Polar)	aM!	atttn<CR><LF> e.g. a0003
Send Data	aD0!	a<dir><mag><status><CR><LF> e.g. 0+083+000.02+00<CR><LF>
Start Measurement (UV)	aM1!	atttn<CR><LF> e.g. a0003
Send Data	aD0!	a<U><V><status><CR><LF> e.g. 0+000.00+000.02+00<CR><LF>
Start Measurement with CRC (Polar)	aMC!	atttn<CR><LF> e.g. a0003
Send Data	aD0!	a<dir><mag><status><CRC><CR><LF> e.g. 0+295+000.01+00B{T<CR><LF>
Start Measurement with CRC (UV)	aMC1!	atttn<CR><LF> e.g. a0003
Send Data	aD0!	a<U><V><status><CRC><CR><LF> e.g. 0+000.00+000.00+00JZY<CR><LF>
Acknowledge Active	a!	a<CR><LF> e.g. 0<CR><LF>
Send Identification	al!	a13GillInst 2487 B06 <sn><CR><LF> e.g. 013GillInst 2487B0611220012<CR><LF>
Change Address	aAb!	b<CR><LF> e.g. 1<CR><LF>
Address Query	?!	a<CR><LF> e.g. 0<CR><LF>
Measurement on demand	aXLPM!	0LP<CR><LF>
Continuous Reading	aXHPM!	0HP<CR><LF>

Appendix G – Configuration Commands

COMMAND	USER
B	Baud rate
C	Analogue angle wrapping
D	Diagnostic and Configuration
E	Set Physical Comms
F	Data and Parity Options
G	Not currently used
H	Power-Up message
K	Minimum Direction Velocity
L	Message Terminator
M	Message Format
N	Unit ID
O	ASCII Output format
P	Output rate
Q	MEASUREMENT MODE
S	Analogue output range
T	Analogue output type
U	Select Units
Y	Analogue Output, Error Status Condition
*	INTERACTIVE MODE

Bx – Baud rate

Item	Options	Command
Baud rate	2400	B1
	4800	B2
	9600	B3
	19200	B4
	38400	B5
<p>To change the Baud rate when using a terminal package- E.g. If set to B3 (9600 baud) and it is required to set to Baud rate to B2 (4800 baud). Type Q to enter Configuration Mode. Type B 2 and press ENTER. (Do not type any further commands at this stage). Close the command line window. Open a terminal package and set serial port Baud Rate to 4800 baud. Type B and press ENTER, the letter B will be shown followed by Capitol B2 Type Q and press ENTER, data will scroll at the new baud rate.</p>		

Cx – Analogue settings

The following command is only valid for the WindSonic Option 3:

Item	Options	Command
Analogue Wraparound (Chart recorder facility)	Wrap around 0 – 539°	C1
	Normal 0 - 359°	C2

Dx – Diagnostic and Configuration Command (See page 62-63 Appendix G)

Ex – Communications Protocol

Item	Options	Command
Communications protocol	RS422 / RS485 (point to point)	E2
	RS232	E3
To change settings, refer to Connecting to a PC (Para's 4.6 and 4.7)		

Option 1 unit default set for E3.

Note that the E2 command will be unavailable on option 1 units.

Option 2 and 3 unit default setting will be E2

Fx – Data and parity options

Item	Options	Command
Data and parity options	8 bits, no parity	F1
	8 bits, even parity	F2
	8 bits, odd parity	F3

Gx – (To be allocated for future developments)

Item	Options	Command
To be allocated	Not Applicable	Gx

Hx – Power-up Message

Item	Options	Command
Power –up message	ON OFF	H1 H2
<p>If the power up message is On, then a message similar to that below is output, whenever the unit goes into Measurement mode (i.e., when power is first applied to the unit, or unit returns to Measurement mode from Configuration mode).</p> <p>WINDSONIC (Gill Instruments Ltd) 2368-110-01 RS485/RS422 (CFG) CHECKSUM ROM: E15C E15C *PASS* CHECKSUM FAC:0A42 0A42 *PASS* CHECKSUM ENG:12BE 12BE *PASS* CHECKSUM CAL:C980 C980 *PASS*</p> <p>If any of these checksums fail, the word PASS will be replaced by FAIL and the unit will use its default settings. If the checksum repeatedly fails after power on – contact your supplier.</p>		
 The exact message above may vary.		

Kxx to Kxxxx – Minimum Direction Velocity

Item	Options	Command
Minimum Direction Velocity	0.00m/s to 5m/s	K50 KXX to KXXXX
<p>This feature allows the minimum wind velocity to be set at which display of the direction is enabled in thousandth of a metre per second. The default is 50, which means that any wind magnitude less than 0.05m/s will have the wind direction omitted in Comma Separated Variable mode.</p> <p>E.g. Q,,000.04,M,3C.</p> <p>Or last wind reading at 0.05m/s or above repeated in Fixed Field Mode.</p> <p>E.g. Q,237,000.04,M,3C.</p>		

Lx – Message Terminator

Item	Options	Command
Message terminator	<CR> <LF>	L1
	<CR>	L2

Mx to Mxx – Message Format

Message Format	Gill, UV, Continuous	M1
	Gill, Polar, Continuous	M2
	Gill, UV, Polled	M3
	Gill, Polar, Polled	M4
	NMEA, IIMWV (NMEA status code)	M5
	Tunnel Continuous	M12
	NMEA, WIMWV (NMEA status code)	M14
	NMEA, WIMWV (Gill status code) NMEA, IIMWV (Gill status code)	M15
	M16	

Nx – Node Address

Node Address	Q... - (A to Z)	N<Q>
--------------	-----------------	------

If used in polled mode then it is recommended that ID's A to F and K, M, N and P are not used, as these characters can be present in the data string.

Ox – ASCII Output Format

Item	Options	Command
ASCII output format	Comma separated format (CSV)	O1
	Fixed field	O2

Example data string for CSV data changing to low wind less than 0.05m/s (set for K50) and error status code condition.

Q,156,000.05,M,00,19

Q,,000.04,M,00,2A (low wind, no direction figure output at 0.04m/s or lower).

Q,100,000.09,M,00,16

Q,,,M,04,24 (error data, no figures output in wind fields).

Example data string for Fixed Field data changing to low wind less than 0.05m/s (set for K50) and error status code condition.

Q,160,000.05,M,00,1C

Q,160,000.04,M,00,1D (low wind, last direction figure at 0.05m/s or above retained).

Q,170,000.06,M,00,1E

Q,999,999.99,M,04,0A (error data, wind fields padded with 9's).

Px to Pxx – Output Rate

Item	Options	Command
Output rate	1 per second	P1
	2 per second	P2
	4 per second	P3
	1 reading every 4 seconds	P20
	1 reading every 2 seconds	P21

Q – Measurement Mode

Refer to Appendix E p.51 (Returning to Measurement mode)

Sx – Analogue Output Range

The following command is only valid for the WindSonic Option 3:

Item	Options	Command
Analogue Range, Magnitude Scaling (Set Analogue Output Range)	0 – 5 metres per second	S1
	0 – 10 metres per second	S2
	0 – 20 metres per second	S3
	0 – 30 metres per second	S4
	0 – 40 metres per second	S5
	0 – 50 metres per second	S6
	0 – 60 metres per second	S7
	0 – 80 metres per second (0-80m/s WindSonic 75 only)	S8
	Analogue output disabled	S9

Tx – Analogue Output Type (Voltage or Current)

The following command is only valid for the WindSonic Option 3:

Item	Options	Command
Voltage or Current output (Set Analogue Output Type)	0 - 5 Volt	T1
	4 – 20 mA	T3
	0 – 20 mA	T5

Ux – Output Units

Item	Options	Command
Output Units	Metres per second (M)	U1
	Knots (N)	U2
	Miles per hour (P)	U3
	Kilometres per hour (K)	U4
	Feet per minute (F)	U5

Yx – Analogue Output, Error Status Condition

Item	Options	Command
Output Level	Full Scale level toggling	Y1
	Fixed Steady level	Y2 nnn
	Pre-Set level toggling	Y3 nnn

Where nnn =000 to 200 see section 6.13.



This command is not applicable to WindSonic 75 analogue output units.

Configuration / Diagnostic Information

Each of these commands causes a response from the WindSonic.

Item	Command	Response
Type and serial No.	D1	Y16120001
Software version	D2	2368-110-01
Unit configuration	D3	M2, U1, O1, L1, P1, B3, H1, NQ, F1, E2, T1, S4, C2, G0, K50,
Supply Voltage	D5	+11.7v

Item	Command	Response
Self-test	D6	<p>See Section 12.2 Self-Test (Still Air)</p> <p>ALIGNMENT LIMITS:0D59,0CF5</p> <p>ALIGNMENT U: OD15 *PASS*</p> <p>ALIGNMENT V: OD16 *PASS*</p> <p>CHECKSUM ROM: AB7D AB7D *PASS*</p> <p>CHECKSUM FAC:04F4 04F4 *PASS*</p> <p>CHECKSUM ENG:082A 082A *PASS*</p> <p>CHECKSUM CAL: A9C1 A9C1 *PASS*</p>
Hardware Configuration	D10	<p>Serial Number: Y16120001</p> <p>Software Version: 2368-110-01</p> <p>Class: WINDSONIC (Gill Instruments Ltd)</p> <p>Number of axes on this unit: 2</p> <p>Axes tilted 45deg to horizontal plane</p> <p>Analogue outputs: 2 (12bit)</p> <p>Analogue output modes: 0-5V 4-20mA 0-20mA</p> <p>Maximum output rate: 004Hz</p> <p>Maximum base rate on this unit is 16Hz sampling</p> <p>Available baud rates: 002400 004800 009600 019200 038400</p> <p>Available messages: M1 M2 M3 M4 M5 M12 M14 M15 M16</p> <p>Safe mode enabled</p> <p>Parity control allowed: F1 F2 F3</p> <p>Communication modes: RS232 RS485/422</p>

Appendix H - Polled Mode Commands

Gill format – Polled (Polar or UV)

When in the Polled mode, an output is only generated when the host system sends a Poll signal to the WindSonic consisting of the WindSonic Unit Identifier – that is, the relevant letter A – Z.

The output formats are otherwise as described in Sections 6.1 and 6.2.

The commands available in this mode are:

Description	Command	WindSonic response
WindSonic Unit Identifier	A Z	Wind speed output generated
Enable Polled mode	?	(None)
Disable Polled mode	!	(None)
Request WindSonic Unit Identifier	? &	A Z (as configured)
Enter Configuration mode	*<N>	CONFIGURATION MODE

Where <N> is the unit identifier, it is recommended that ID's A to F and KMNP are not used as these characters can be present in the data string.

Notes: -

It is suggested that in polled mode the following sequence is used for every poll for information.

? Ensures that the Sensor is enabled to cover the event that a power down has occurred.

A-Z Appropriate unit designator sent to retrieve a line of data.

! Sent to disable poll mode and reduce possibility of erroneous poll generation.

When in polled mode the system will respond to the data command within 130mS with the last valid data sample as calculated by the Output rate (P Mode Setting).

If the unit is powered down after use or upon switch on, then allow 5 seconds from switch on before sending poll commands.

Polled mode can only be used for point-to-point communications. It is not possible to network units on a common bus

Appendix I - Wind View Software

Gill WindView software is available to download, free of charge from the Gill Instruments Limited website <http://gillinstruments.com/main/software.html>

WindView features include: -

- Data Display
- Data Logging



WindView cannot be used to change the WindSonic configuration.

WindView is not compatible with WindSonic Option 4 – SDI-12 or WindSonic units prior to serial number 08100001 with a yellow or blue tab adjacent to the North Marker.

Open Gill WindView software program.

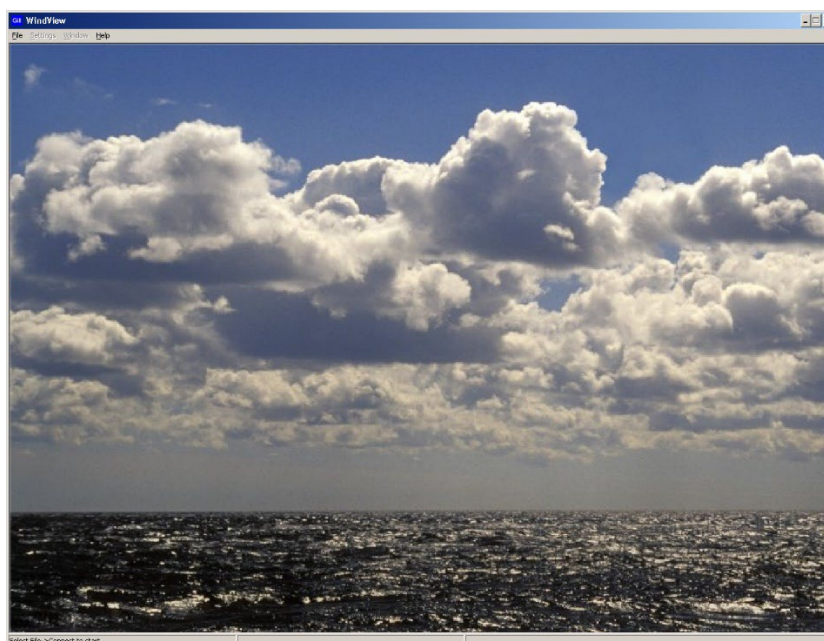

Select File/Connect as follows: -

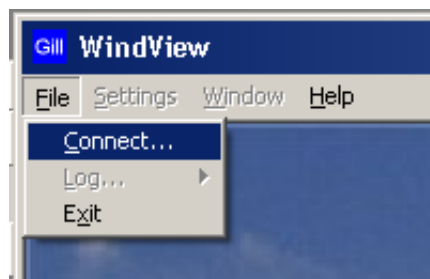

Select the required COM Port from the drop-down list.

Select the required Baud rate from the drop-down list.

Parity should be set to none.

If the Baud rate setting of the Anemometer is unknown, then the Auto Find button can be used to interrogate the Anemometer and detect the required setting.

Click on the Connect button.

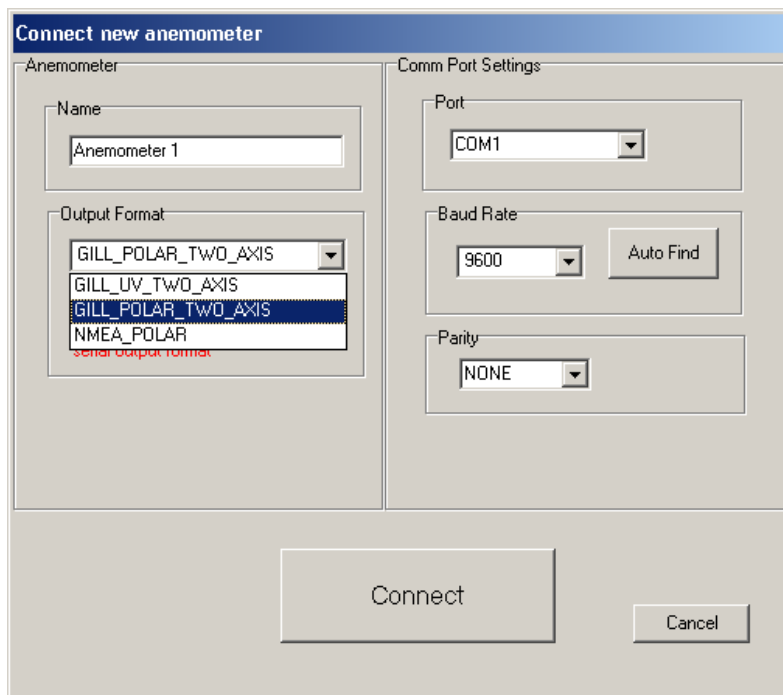

Data should scroll on the screen as follows (Data button).

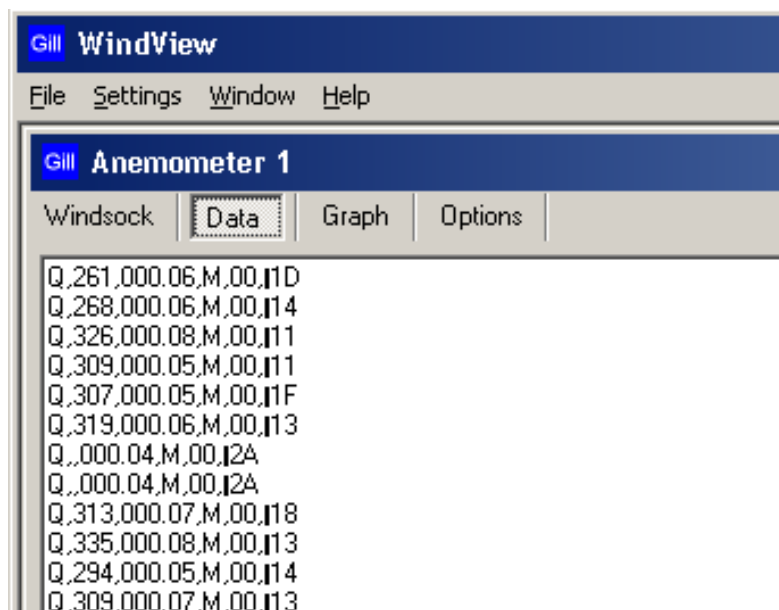

Clicking on the Anemometer 1 Windsock button gives the following display.

To Change WindView Display Settings

Click on the top of Screen menu Settings.

To change displayed units select and click on required measurement units. If for instance the sensor data was outputting metres per second data then WindView performs the calculation to convert and display the output in knots/mpg/kph etc.

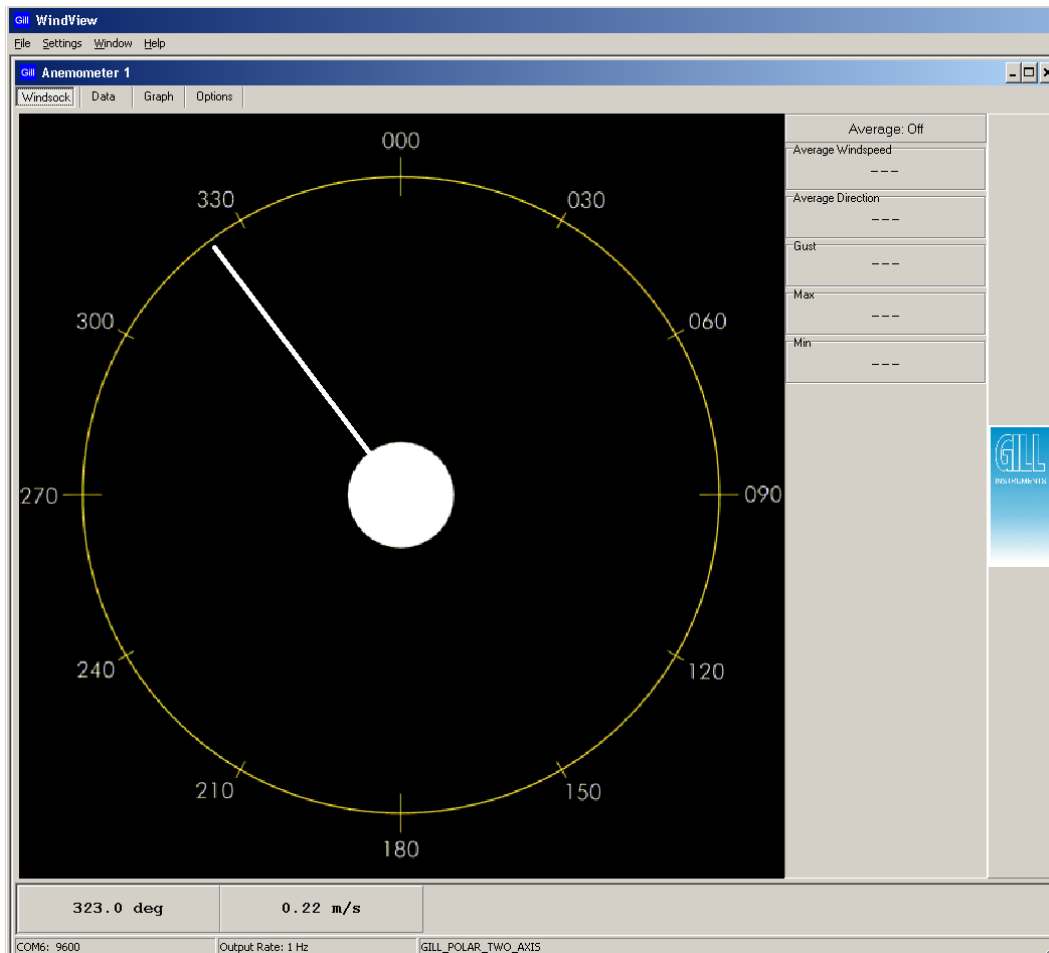

For Logging Facilities.

Click on Settings/Logging to reach the logging screen.

If segmented logging is required this will create and save individual files of length set by the figure in the mins box. Otherwise a continuous log file will be recorded.

Select required Directory for saved file and File name.

Click on Apply.

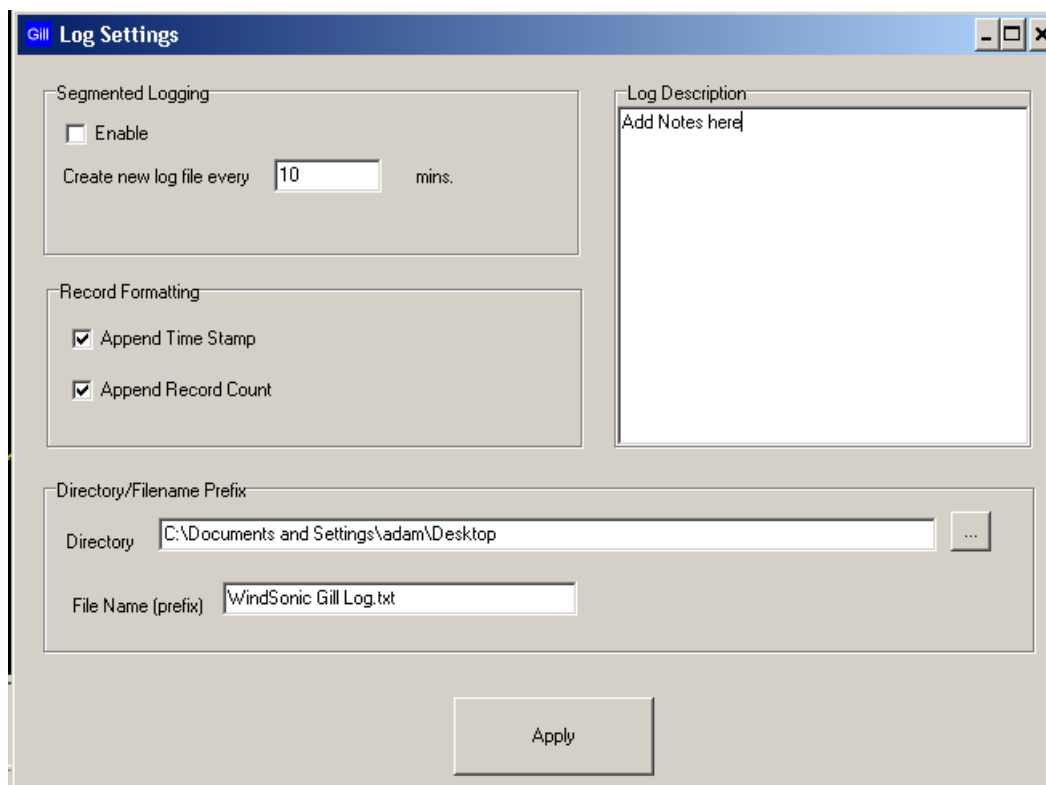

The screenshot shows the 'Gill Log Settings' dialog box. It is divided into several sections:

- Segmented Logging:** Contains an unchecked checkbox for 'Enable'. Below it is a text field 'Create new log file every' with the value '10' and the unit 'mins'.
- Record Formatting:** Contains two checked checkboxes: 'Append Time Stamp' and 'Append Record Count'.
- Directory/Filename Prefix:** Contains a 'Directory' text field with the path 'C:\Documents and Settings\adam\Desktop' and a browse button (...). Below it is a 'File Name (prefix)' text field with the value 'WindSonic Gill Log.txt'.
- Log Description:** A large text area on the right with the placeholder text 'Add Notes here'.
- Apply:** A button at the bottom center of the dialog.

Click on the OK button.

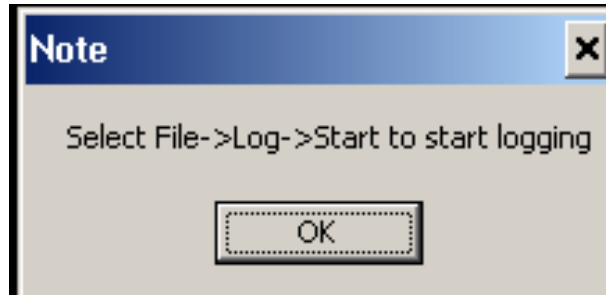

To Start Logging select File/Log/Start.

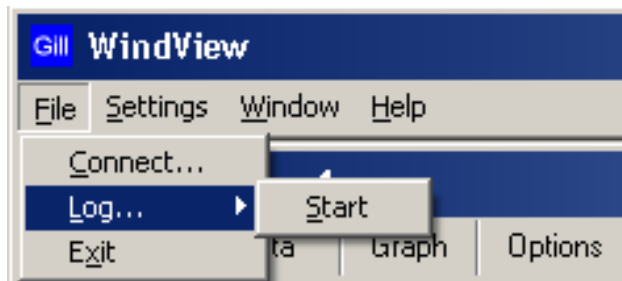

To stop logging select File/Log/Stop.

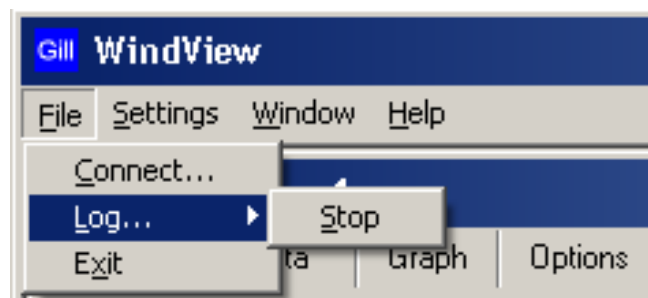

Example saved data opened in Notepad.

```
File Edit Format View Help
windView Log File
Add Notes here
windSonic log test
Name: Anemometer 1
Output Format: GILL_POLAR_TWO_AXIS
Log file opened: 13/06/2008 10:50:09
Q,322,000.22,M,00,01D,1,13/06/2008 10:50:10
Q,307,000.22,M,00,01A,2,13/06/2008 10:50:11
Q,342,000.28,M,00,011,3,13/06/2008 10:50:12
Q,320,000.29,M,00,014,4,13/06/2008 10:50:13
Q,340,000.12,M,00,01A,5,13/06/2008 10:50:14
Q,312,000.21,M,00,01D,6,13/06/2008 10:50:15
Q,318,000.37,M,00,010,7,13/06/2008 10:50:16
Q,321,000.26,M,00,01A,8,13/06/2008 10:50:17
Q,291,000.19,M,00,01C,9,13/06/2008 10:50:18
Q,312,000.14,M,00,01B,10,13/06/2008 10:50:19
Q,314,000.20,M,00,01A,11,13/06/2008 10:50:20
```

Appendix J - Status Codes

Option 1-3 Status Codes

The Status code is sent as part of each wind measurement message.

Code	Status	Condition
00	OK	Sufficient samples in average period
01	Axis 1 failed	Insufficient samples in average period on U axis
02	Axis 2 failed	Insufficient samples in average period on V axis
04	Axis 1 and 2 failed	Insufficient samples in average period on both axes
08	NVM error	NVM checksum failed
09	ROM error	ROM checksum failed
A	-	NMEA data Acceptable
V	-	NMEA data Void

SDI-12 Status Codes

Code	Status	Condition
00	OK	Sufficient samples in average period
01	Axis 1 failed	Insufficient samples in average period on U axis
02	Axis 2 failed	Insufficient samples in average period on V axis
04	Axis 1 and 2 failed	Insufficient samples in average period on both axes
08	NVM error	NVM checksum failed
09	ROM error	ROM checksum failed
51	Measurement average building	Will be output up to 68 seconds after power up whilst initialisation and 1 minute averaging calculations take place when in High Power mode.

Appendix K - Maintenance & Fault-Finding

Cleaning

If there is any build-up of deposit on the unit, it should be gently cleaned with a cloth moistened with soft detergent. Solvents should not be used, and care should be taken to avoid scratching any surfaces. The unit must be allowed to defrost naturally after being exposed to snow or icy conditions, do NOT attempt to remove ice or snow with a tool.



Do NOT remove black “rubber” transducer caps.

Servicing

There are no moving parts or user-serviceable parts requiring routine maintenance.

Opening the unit or breaking the security seal will void the warranty and the calibration.

In the event of failure, prior to returning the unit to your authorised Gill distributor, it is recommended that:

1. All cables and connectors are checked for continuity, bad contacts, corrosion etc.
2. A bench test is carried out as described on page 74 (Bench Test)
3. You contact your supplier for advice

Fault Finding

Symptom	Solution
No output	<p>Check DC power to WindSonic, cable and connections.</p> <p>Check comms settings of WindSonic and host system match, including correct Com port</p> <p>Check unit is in Continuous mode</p> <p>Check that in-line communication devices are wired correctly.</p> <p>NOTE: It is usual for Anemometer TX + to be connected to converter device RX +</p>
Corrupted output	<p>Check comms settings of WindSonic and host system match.</p> <p>Try a slower baud rate.</p> <p>Check cable lengths and type of cable.</p>
One way communication	<p>Check WindSonic and host system are both set to the same protocol RS232, RS422, or RS485.</p> <p>Check wiring is in accordance with the manual.</p>
Failed / Incorrect WindSonic output, data invalid flag	<p>Check that transducer path is not blocked</p>

Returning Unit

If the unit has to be returned, it should be carefully packed in the original packaging and returned to your authorised Gill distributor, with a full description of the fault condition.

Bench Test

1. Couple the WindSonic to the host system and power supply, using a known working test cable.
2. Check that the unit is correctly configured by going into Configuration mode and using D3 See *Appendix G Checking the configuration*.
3. Check for normal output data, and that the Status Code is OK – 00 (or A for NMEA format).
4. If the status code is other than 00 or A, refer to Appendix J Status (error) codes.
5. Use an office fan or similar to check that the unit is sensing wind, turning the unit to simulate changing wind direction and to check that both axes are functioning.
6. Note that this is a quick functional test. There are no calibration adjustments; the unit is designed NOT to require re-calibration within its lifetime.

Self – Test (Still Air)

This test checks Alignment and Checksums.

Alignment tests: The unit performs a transducer geometry check and compares the result with its factory setting.

Checksum tests: The unit performs a check of its program and data memory.



This test is a stringent laboratory test, which will only be passed if carried out under still air conditions at room temperature (17-23°C).



1. Use the original packing box (inner and outer) to enclose the unit. (The packaging is designed as a zero-wind enclosure).
2. Go into Configuration Mode .
3. Carry out the Self-test by entering .

A message similar to that shown below will be generated:

```
ALIGNMENT LIMITS:0D59,0CF5
ALIGNMENT U: OD15 *PASS*
ALIGNMENT V: OD16 *PASS*
CHECKSUM ROM: AB7D AB7D *PASS*
CHECKSUM FAC:04F4 04F4 *PASS*
CHECKSUM ENG:082A 082A *PASS*
CHECKSUM CAL: A9C1 A9C1 *PASS*
```

For each of the Alignment tests a Pass or Refer to Manual message is generated.

For each of the Checksum tests a Pass or Fail message is generated.

4. If any of the tests fail, contact your supplier.
If a "refer to manual" message appears please *see Appendix K Fault Finding*.



That it will only pass if the specified temperature and zero wind conditions are met

Check that there are no visible obstructions or damage to the unit before contacting Gill or your authorised distributor for further advice.

Calibration

A Custom calibration is available from Gill Instruments. This must be specified at the time of order, or the unit must be returned to Gill Instruments for retrospective calibration.

Appendix L - Glossary & Abbreviations

Item	Meaning
CAL	Calibration
CR	Carriage Return
CSV	Comma Separated Variable
ENG	Engineering
FAC	Factory
KPH	Kilometres per Hour
LF	Line Feed
MPH	Miles per Hour
NMEA 0183 (version 3)	National Marine Electronics Association standard for interfacing marine electronic navigational devices
NVM	Non-Volatile Memory
PC	IBM compatible Personal Computer
ROM	Read Only Memory
RS232	Communications standard
RS422	Communications standard
RS485	Communications standard
RXD	Received Data
TXD	Transmitted Data
SDI-12	Serial – Data Interface standard for microprocessor-based sensors
WMO	World Meteorological Organisation

Appendix M – Guarantee, FCC & EMC

Guarantee

For terms of guarantee contact your supplier or refer to the Gill Instruments Terms & Conditions here:

<https://gill.group/wp-content/uploads/Gill-Group-Company-Terms-Conditions-of-Sale-9170-0003-Issue-02-March-20...pdf>

FCC

WindSonic complies with part 15 of the FCC Rules. Operation is subject to the following two conditions: -

- (1) This device may not cause harmful interference, and
- (2) This device must accept any interference received, including interference that may cause undesired operation.

This equipment has been tested and found to comply with the limits for a Class A digital device, pursuant to part 15 of the FCC Rules. These limits are designed to provide reasonable protection against harmful interference when the equipment is operated in a commercial environment. This equipment generates, uses, and can radiate radio frequency energy and, if not installed and used in accordance with the instruction manual, may cause harmful interference to radio communications. Operation of this equipment in a residential area is likely to cause harmful interference in which case the user will be required to correct the interference at his own expense.

EMC

Immunity test requirements for equipment intended to be used in an industrial electromagnetic environment have been applied. These test levels are above the levels expected to be experienced in normal use due to the above recommended siting conditions, but disturbances may be expected. If any interruption to performance is experienced due to external electromagnetic signals the product will automatically and autonomously return to specification once the signals levels have diminished.

